

The world's [**FASTEST**] ducting

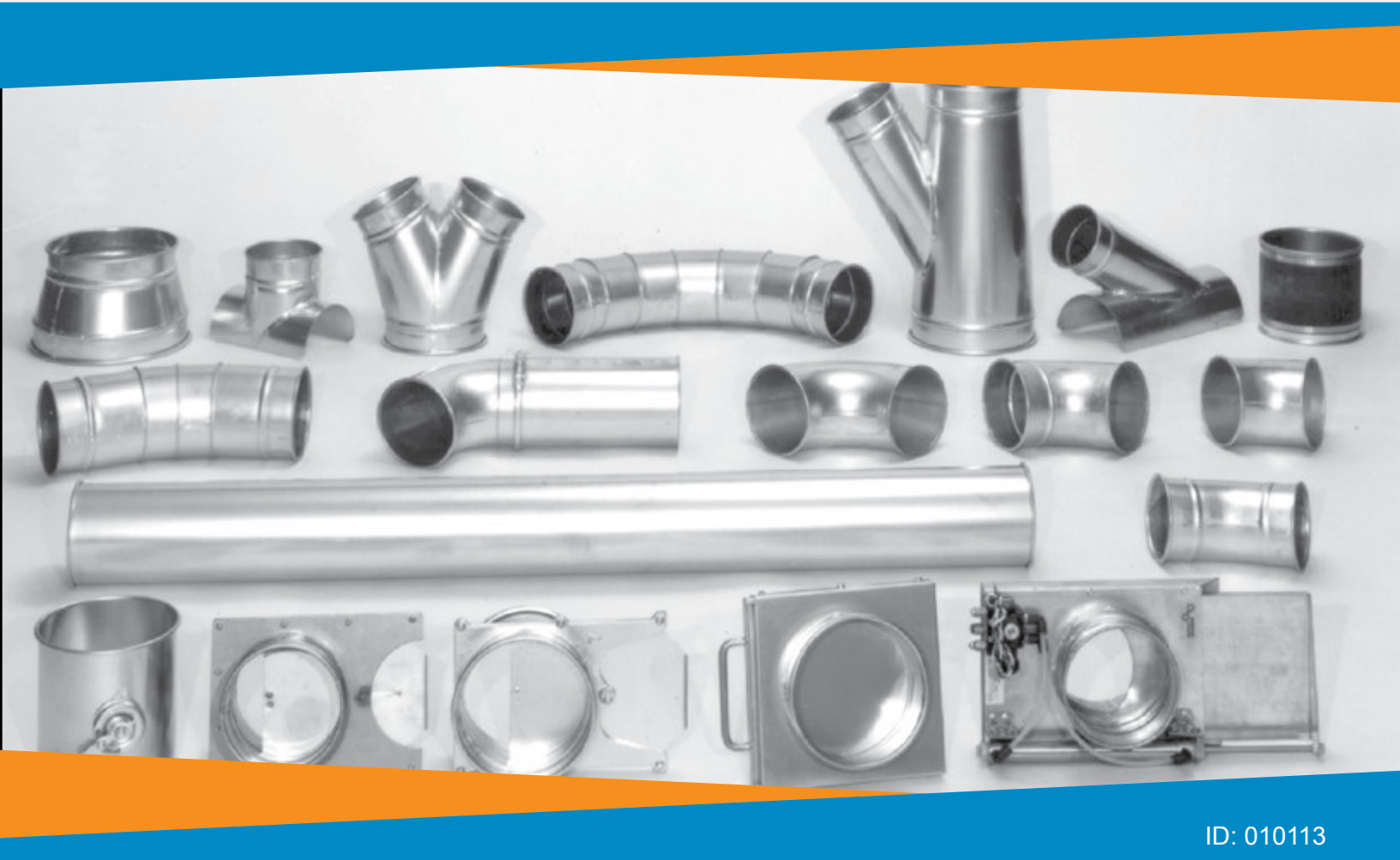

ID: 010113

- Easy & fast to install
 - Easy Clean
 - Laser welded seams
 - Re-useable
- Cuts installation and downtime by more than 45%

QUICK-FIT

Catalog



Made in the USA

REGISTERED
ISO
9001:2008
14001:2004

Who Uses Quick-Fit

Quick-Fit is very popular among any industry that needs to deal with the collection and removal of Dust, Fume or Mist.

Some of those industries include:

- Agriculture
- Automotive
- Boatbuilding
- Concrete
- Food Processing
- Furniture
- Metalworking
- Mining
- Paper
- Plastics
- Powder, Bulk and Solids
- Recycling
- Textiles
- Woodworking



Paper

Quick-Fit is used to convey dozens of materials.

Below is a list of some of them:

- Agricultural dusts
- Carbon dust
- Cardboard trim
- Chemical solids
- Chemical fumes
- Concrete dust
- Condensation
- Cutting fluid mists
- Diaper fluff
- Flour
- Food dusts
- Food products
- Fume exhausts
- Metal dusts or shavings
- Milk powder
- Oil mists
- Oven exhausts
- Paint products
- Paper
- Petrochemicals
- Pharmaceuticals
- Plastic dusts
- Salt
- Smoke
- Spices
- Sugar
- Textile dusts and streamers
- Vehicle exhausts
- Welding fumes
- Wood dusts



Tomato processing



Machining



Lime processing

















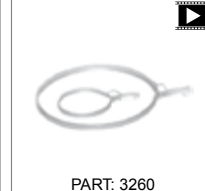



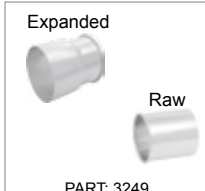















Concrete













Poultry

To see our video on Quick-Fit, visit our website www.diversair.com

CONTENTS

<p>QF Pipe</p>  <p>PART: 3200</p> <p>Page 5</p>	<p>Flanged Pipe</p>  <p>PART: 3201</p> <p>Page 5</p>	<p>Heavy Wall & 18ga Pipe</p>  <p>PART NO. 3200-XXHG PART NO. 3200-XX18</p> <p>Page 5</p>	<p>Adjustable Nipple 18ga</p>  <p>PART NO. 3202-XX18</p> <p>Page 5</p>	<p>Heavy Wall Nipple</p>  <p>PART NO. 3201-XXHG</p> <p>Page 5</p>	<p>Clamps</p>  <p>PART: 3260</p> <p>Page 6</p>	<p>Adjustable Nipple</p>  <p>PART: 3202</p> <p>Page 6</p>
<p>Hose Adapter</p>  <p>PART: 3282</p> <p>Page 11</p>	<p>Bell Mouth Adapter</p>  <p>PART: 3251</p> <p>Page 11</p>	<p>Machine Adapter</p> <p>Expanded</p>  <p>Raw</p> <p>PART: 3249</p> <p>Page 11</p>	<p>Angle Flange Adapter</p>  <p>PART: 3250</p> <p>Page 11</p>	<p>Branch</p>  <p>PART: 3220</p> <p>Page 12</p>	<p>Y Branch</p>  <p>PART: 3221</p> <p>Page 12</p>	<p>Double Branch</p>  <p>PART: 3226</p> <p>Page 12</p>
<p>SD Auto Blast Gate</p>  <p>PART: 3242</p> <p>Page 15</p>	<p>Blast Gate Manual</p>  <p>PART: 3240</p> <p>Page 16</p>	<p>Blast Gate NFMES Manual</p>  <p>PART: 3241</p> <p>Page 16</p>	<p>Custom Manifold</p>  <p>Page 27</p>	<p>Transition Rectangular to Round</p>  <p>PART: 3225</p> <p>Page 14</p>	<p>Router Hood</p>  <p>PART: 3231 with Magnet PART: 3232</p> <p>Page 14</p>	<p>Viewing Spool</p>  <p>PART: 3205</p> <p>Page 23</p>
<p>Hose Clamp</p>  <p>PART: 3285</p> <p>Page 17</p>	<p>Manual Diverter Valve</p>  <p>PART: 3235</p> <p>Page 18</p>	<p>Automatic Diverter Valve</p>  <p>PART: 3236</p> <p>Page 18</p>	<p>SD Diverter Valves</p>  <p>PART NO. 3233 (Manual) PART NO. 3234 (Auto)</p> <p>Page 18</p>	<p>Butterfly Valve</p>  <p>PART: 3208</p> <p>Page 23</p>	<p>In Line Back Draft Damper</p>  <p>PART: 3219</p> <p>Page 21</p>	<p>Pipe Hanger</p>  <p>PART: 3265</p> <p>Page 19</p>
<p>Leak-Free Epoxy Caulking</p>  <p>Page 20</p>	<p>Tuff Shield Lining</p>  <p>Page 20</p>	<p>Vibration Isolator</p>  <p>PART: 3206</p> <p>Page 22</p>	<p>No-Loss Stackhead</p>  <p>PART: 3204</p> <p>Page 22</p>	<p>Jet Cap</p>  <p>PART NO. 3258</p> <p>Page 22</p>	<p>Sliding Access Panel</p>  <p>PART: 3103</p> <p>Page 24</p>	<p>Oil Mist Recycler</p>  <p>PART: 3192</p> <p>Page 24</p>
<p>TDH Fume Arm</p>  <p>PART NO. 8690</p> <p>Page 27</p>						

 Video available on diversair.com

<p>O-Ring</p>  <p>PART: 3262 Page 6</p>	<p>Silencer</p>  <p>PART: 3106 Page 7</p>	<p>Angle Flange</p>  <p>PART: 3261 Page 7</p>	<p>Elbows</p>  <p>PART: 3210 Page 8</p>	<p>Elbow Flanged</p>  <p>PART: 3211 Page 9</p>	<p>Tubed Elbows</p>  <p>PART: 3214 Page 10</p>	<p>Heavy Wall Elbow</p>  <p>PART: 3212 Page 9</p>
<p>T-Branch</p>  <p>PART: 3227 Page 11</p>	<p>In Cut</p>  <p>PART: 3223 Page 13</p>	<p>Tap In</p>  <p>PART: 3224 Page 13</p>	<p>End Cap</p>  <p>PART: 3151 Page 13</p>	<p>End Cap With Bird Screen</p>  <p>PART: 3152 Page 13</p>	<p>Reducer</p>  <p>PART: 3222 Page 13</p>	<p>Blast Gate NFES Automatic</p>  <p>PART: 3245 Page 15</p>
<p>Ball Joint</p>  <p>PART: 3209 Page 14</p>	<p>Suction Hood</p>  <p>PART: 3230 Page 14</p>	<p>Rubber Hose</p>  <p>PART: 3280 Page 17</p>	<p>Rigid Flex Steel Hose</p>  <p>PART: 3281 Page 17</p>	<p>Ultra Flex Steel Hose</p>  <p>PART: 3283 Page 17</p>	<p>Radial Armsaw Hood</p>  <p>PART: 3229 Page 23</p>	<p>Floor Sweep</p>  <p>PART: 3248 Page 21</p>
<p>Pipe Bracing</p>  <p>PART: 3268 Page 19</p>	<p>Gripple Hanger</p>  <p>PART: 3266 Page 19</p>	<p>Beam Clamp</p>  <p>PART: 3269 Page 19</p>	<p>Pipe Hanger HJ</p>  <p>PART: 3265HJ Page 19</p>	<p>Strut Hanger</p>  <p>PART NO. 3265 Page 19</p>	<p>Leak-Free Gasket</p>  <p>PART: 3190 Page 20</p>	<p>Leak-Free O-ring</p>  <p>PART: 3191 Page 20</p>
<p>Bleed in Valve</p>  <p>PART: 3207 Page 23</p>	<p>Wall Flashing</p>  <p>PART NO. 3238 Page 25</p>	<p>Roof Flashing</p>  <p>PART NO. 3237 Page 25</p>	<p>Roof Skirt</p>  <p>PART NO. 3239 Page 25</p>	<p>Sizing a System</p>  <p>Page 29</p>	<p>Adjustable Nipple Instructions</p>  <p>Page 28</p>	<p>Install Tips</p>  <p>Page 30</p>
<p>Explosion Isolation Flap</p>  <p>Page 26</p>						

 Video available on diversair.com

QF PIPE

Ø	PART NO.	ENDS	ID (IN.)	OD (IN)	GAUGE GAL	GAUGE SS	ROLL (D)	LENGTH
3"	3200-0300	QF	2.90	3.00	18	18	0.2	59.25"
4"	3200-0400	QF	3.86	3.93	22	22	0.2	59.25"
5"	3200-0500	QF	4.87	4.94	22	22	0.2	59.25"
6"	3200-0600	QF	5.89	5.96	22	22	0.2	59.25"
7"	3200-0700	QF	6.89	6.96	22	22	0.3	59.06"
8"	3200-0800	QF	7.88	7.95	22	22	0.3	59.06"
9"	3200-0900	QF	8.88	8.95	22	22	0.3	59.06"
10"	3200-1000	QF	9.89	9.95	22	22	0.3	58.75"
11"	3200-1100	QF	10.88	10.94	22	22	0.3	58.75"
12"	3200-1200	QF	11.97	12.04	22	22	0.4	58.75"
13"	3200-1300	QF	12.97	13.05	20	20	0.4	58.75"
14"	3200-1400	QF	13.96	14.04	20	20	0.4	58.75"
15"	3200-1500	QF	14.97	15.04	20	20	0.4	58.75"
16"	3200-1600	QF	15.97	16.04	20	20	0.4	58.75"
17"	3200-1700	QF	16.97	17.05	20	20	0.4	58.75"
18"	3200-1800	QF	17.96	18.04	20	20	0.4	58.75"
20"	3200-2000	QF	19.96	20.04	20	20	0.4	58.75"
22"	3200-2200	QF	21.97	22.05	20	20	0.4	58.75"
24"	3200-2400	QF	23.94	24.02	20	20	0.4	58.75"

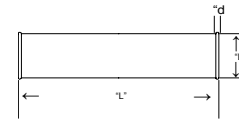

Comes with a leak-proof laser-welded seam and connects quickly and easily with the QF Clamp.

FLANGED PIPE

Ø	PART NO.	ENDS	GAUGE GAL	GAUGE SS	LENGTH
3"	3201-XX00	FLANGE	18	18	59.25"
4"	3201-XX00	FLANGE	22	22	59.50"
5"-11"	3201-XX00	FLANGE	20	22	78"
12"	3201-XX00	FLANGE	20	20	78"
13"	3201-XX00	FLANGE	20	20	78"
14"	3201-XX00	FLANGE	20	20	78"
15"	3201-XX00	FLANGE	20	20	78"
16"-28"	3201-XX00	FLANGE	20	20	78"
30"-40"	3201-XX00	FLANGE	18	20	78"

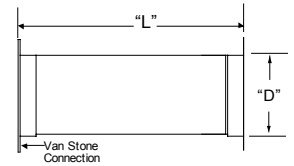
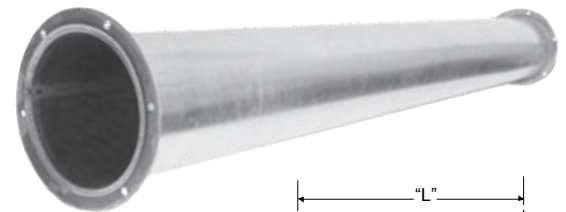

Use this duct system for sizes over 24" dia. Angle flange attached by Van Stone lip.

QF PIPE 18GA

Ø	PART NO.	GAUGE GAL	LENGTH
4-6"	3200-XX18-100000	18	59.25"
7-9"	3200-XX18-100000	18	59.0625"
10-24"	3200-XX18-100000	18	58.75"



ADJUSTABLE NIPPLE 18GA

Ø	PART NO.	GAUGE GAL	LENGTH
4-6"	3202-XX18-100000	18	11 3/8"
7-10"	3202-XX18-100000	18	11 1/8"
11-24"	3202-XX18-100000	18	10 7/8"



HEAVY WALL DUCTING

Ø	PART NO.	GAUGE GAL	LENGTH
8-9"	3200-XXHG-100000	16	59.0625"
10-24"	3200-XXHG-100000	16	58.75"



HEAVY WALL NIPPLE

Ø	PART NO.	GAUGE GAL	LENGTH
8-9"	3201-XXHG-100000	16	60"
10-24"	3201-XXHG-100000	16	60"





QUICK-FIT

THE WORLD'S FASTEST DUCTING

ADJUSTABLE NIPPLE CLAMPS O-RING

CLAMP WITH PIN

Ø	PART NO.
3"-24"	3260-XX00-X00000
ADDITIONAL PINS	
LARGE BRIDGE PINS	3260-PINS-LARGE0
SMALL BRIDGE PINS	3260-PINS-SMALL0
ADDITIONAL NITRILE SEALS	
3" - 6"	3260-0375-SP3000
7" - 11"	3260-0500-SP4000
12" - 24"	3260-0650-SP5000

The best-sealing and best selling clamp in the dust, mist and fume collection industry. Standard clamps come with Nitrile seals to help prevent leakage over multiple uses.

CLAMP WITH ePTFE SEAL

Ø	PART NO.
3"-24"	3260-0300-X00005
ADDITIONAL PINS	
LARGE BRIDGE PINS	3260-PINS-LARGE0
SMALL BRIDGE PINS	3260-PINS-SMALL0
ADDITIONAL INERTECH SEALS	
3" - 6"	3260-0000-SG3000
7" - 11"	3260-0000-SG4000
12" - 24"	3260-0000-SG.650

The best-sealing and best selling clamp in the dust, mist and fume collection industry. Premium ePTFE seals stand up to high temperatures and harsh chemicals to help prevent leakage over multiple uses.

NOTE: We still have a supply of Danish clamps, once we exhaust our supply of those, only US style clamps will be sold.

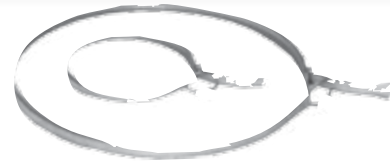

Danish Style

Seal Will Be Installed And Folded Over At The Factory. It Will Release Easily Due To The Pressure Sensitive Backing.

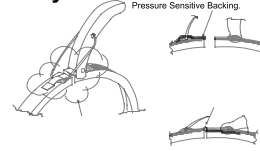

USA Style



- 3" to 6" Clamps: Small bridge pin with 3/8" wide seal from factory
- 7" to 11" Clamps: Large bridge pin with 1/2" wide seal from factory
- 12" to 24" Clamps: Large bridge pin with 5/8" wide seal from factory

ADJUSTABLE NIPPLE WITH O-RING

Ø	PART NO.	ENDS	ID (IN)	OD (IN)	LENGTH (L)	GAUGE GAL	GAUGE SS
3"	3202-0300	QF	3.07	3.15	11 1/4"	22	22
4"	3202-0400	QF	3.96	4.03	11 1/4"	22	22
5"	3202-0500	QF	4.96	5.03	11 1/4"	22	22
6"	3202-0600	QF	5.99	6.06	11 1/4"	22	22
7"	3202-0700	QF	7.00	7.07	11 1/8"	22	22
8"	3202-0800	QF	8.00	8.06	11"	22	22
9"	3202-0900	QF	9.00	9.06	11"	22	22
10"	3202-1000	QF	10.00	10.07	10 7/8"	22	22
11"	3202-1100	QF	11.12	11.19	10 5/8"	22	22
12"	3202-1200	QF	12.11	12.17	10 5/8"	22	22
13"	3202-1300	QF	13.12	13.2	10 5/8"	20	20
14"	3202-1400	QF	14.10	14.18	10 5/8"	20	20
15"	3202-1500	QF	15.12	15.2	10 5/8"	20	20
16"	3202-1600	QF	16.10	16.18	10 5/8"	20	20
17"	3202-1700	QF	17.07	17.15	10 5/8"	20	20
18"	3202-1800	QF	18.10	18.18	10 5/8"	20	20
20"	3202-2000	QF	20.10	20.18	10 5/8"	20	20
22"	3202-2200	QF	22.11	22.19	10 5/8"	20	20
24"	3202-2400	QF	24.06	24.14	10 5/8"	20	20

The adjustable nipple is a sleeve into which a cut length of standard QF pipe can be inserted. The assembly "telescopes" to the desired length and seals with a standard QF Clamp.

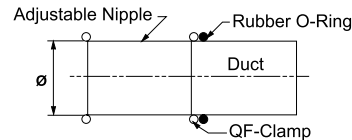

O-RING

Ø	PART NO.
3"-24"	3262-XX00

Used to seal the telescoping QF Adjustable Nipple

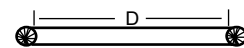

- Replacement O-ring for use with Adj. Nipples.
- Specify Black for standard
- Specify Red for high temp

SILENCER ANGLE FLANGE



QUICK-FIT
THE WORLD'S FASTEST DUCTING

SILENCER

"A"	"OD"	PART NO.	ENDS	LENGTH (C)	GAUGE HOUSING
3"-4"	12"	3106-XX00	QF	28"	20
5"	13"	3106-0500	QF	28"	20
6"	14"	3106-0600	QF	30"	20
7"	15"	3106-0700	QF	30"	20
8"	16"	3106-0800	QF	35"	20
9"	17"	3106-0900	QF	40"	20
10"	18"	3106-1000	QF	48"	20
12"	20"	3106-1200	QF	54"	20
14"	22"	3106-1400	QF	60"	20
16"	24"	3106-1600	QF	64"	20
18"	26"	3106-1800	QF	68"	20
20"	28"	3106-2000	QF	72"	20
22"	30"	3106-2200	QF	76"	20
24"	32"	3106-2400	QF	80"	20
26"	34"	3106-2600	FLANGE	80"	20
28"	36"	3106-2800	FLANGE	80"	20
30"	38"	3106-3000	FLANGE	80"	18
32"	40"	3106-3200	FLANGE	80"	18
34"	42"	3106-3400	FLANGE	80"	18
36"	44"	3106-3600	FLANGE	80"	18
38"	46"	3106-3800	FLANGE	80"	18
40"	48"	3106-4000	FLANGE	80"	18

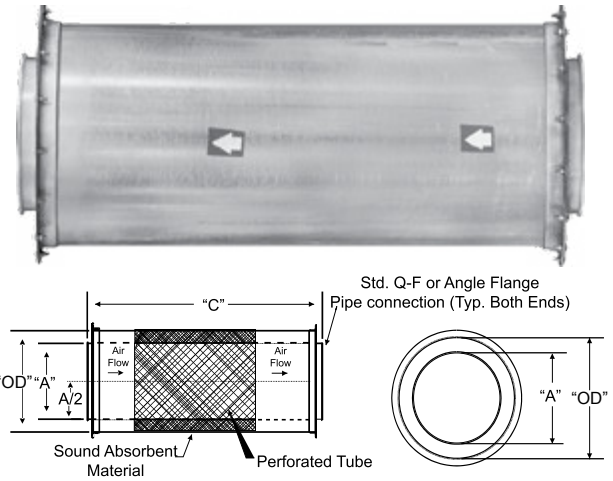

Nordfab silencers can significantly reduce the noise in a dust collection system. Due to varying applications, no decibel testing has been performed on this product.

ANGLE FLANGE

Ø	PART NO.	I.D.	H	W	T	B.C.	NO. OF BOLTS	Ø OF BOLT HOLES
3"	3261-0300	3 1/16"	15/16"	15/16"	1/8"	4 5/16"	6	0.281
4"	3261-0400	4 1/16"	15/16"	1"	1/8"	5 5/16"	6	0.281
5"	3261-0500	5 1/16"	1 1/16"	1"	1/8"	6 5/16"	6	0.281
6"	3261-0600	6 3/32"	1"	1"	1/8"	7 5/16"	6	0.281
7"	3261-0700	7 1/8"	1"	1 1/8"	1/8"	8 1/2"	6	0.375
8"	3261-0800	8 1/8"	1 1/8"	1 1/8"	1/8"	9 5/8"	6	0.375
9"	3261-0900	9 1/8"	1 1/4"	1 1/4"	1/8"	10 5/8"	6	0.438
10"	3261-1000	10 1/8"	1 1/4"	1 3/8"	1/8"	11 4/5"	6	0.438
11"	3261-1100	11 1/8"	1 1/4"	1 1/2"	1/8"	12 3/4"	6	0.438
12"	3261-1200	12 1/8"	1 1/2"	1 1/2"	1/8"	14	8	0.438
13"	3261-1300	13 1/8"	1 1/2"	1 1/2"	1/8"	15	8	0.438
14"	3261-1400	14 1/8"	1 1/2"	1 1/2"	1/8"	16	8	0.438
15"	3261-1500	15 1/8"	1 1/2"	1 1/2"	3/16"	17	8	0.438
16"	3261-1600	16 1/8"	1 1/2"	1 1/2"	3/16"	18	8	0.438
17"	3261-1700	17 1/8"	1 1/2"	1 1/2"	3/16"	19	8	0.438
18"	3261-1800	18 1/8"	1 1/2"	1 1/2"	3/16"	20	8	0.438
19"	3261-1900	19 1/8"	1 1/2"	1 1/2"	3/16"	20 3/4"	12	0.438
20"	3261-2000	20 1/8"	1 1/2"	1 1/2"	3/16"	21 3/4"	12	0.438
21"	3261-2100	21 1/8"	1 1/2"	1 1/2"	3/16"	22 3/4"	12	0.438
22"	3261-2200	22 1/8"	1 1/2"	1 1/2"	3/16"	23 3/4"	12	0.438
23"	3261-2300	23 1/8"	1 1/2"	1 1/2"	3/16"	24 7/8"	12	0.438
24"	3261-2400	24 1/8"	1 1/2"	1 1/2"	3/16"	25 7/8"	12	0.438
25"	3261-2500	25 1/8"	1 1/2"	1 1/2"	3/16"	26 7/8"	16	0.438
26"	3261-2600	26 1/8"	2"	2"	3/16"	28 3/8"	16	0.438
27"	3261-2700	27 1/8"	2"	2"	3/16"	29 3/8"	16	0.438
28"	3261-2800	28 1/8"	2"	2"	3/16"	30 3/8"	16	0.438
29"	3261-2900	29 1/8"	2"	2"	3/16"	31 3/8"	16	0.438
30"	3261-3000	30 1/8"	2"	2"	3/16"	32 3/8"	16	0.438
31"	3261-3100	31 1/8"	2"	2"	3/16"	33 3/8"	16	0.438
32"	3261-3200	32 1/8"	2"	2"	3/16"	34 3/8"	16	0.438
33"	3261-3300	33 1/8"	2"	2"	3/16"	35 3/8"	16	0.438
34"	3261-3400	34 1/8"	2"	2"	3/16"	36 3/8"	16	0.438
35"	3261-3500	35 1/8"	2"	2"	3/16"	37 3/8"	16	0.438
36"	3261-3600	36 1/8"	2"	2"	3/16"	38 3/8"	16	0.438
37"	3261-3700	37 1/8"	2"	2"	3/16"	39 3/8"	24	0.438
38"	3261-3800	38 1/8"	2"	2"	3/16"	40 3/8"	24	0.438
39"	3261-3900	39 1/8"	2"	2"	3/16"	41 3/8"	24	0.438
40"	3261-4000	40 1/8"	2"	2"	3/16"	42 3/8"	24	0.438

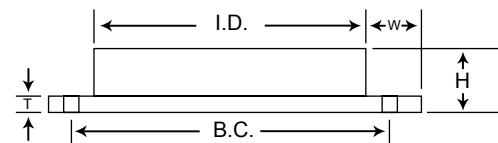

Other drill patterns available in flat flange.

Nordfab carries a huge inventory of angle flanges and can deliver most orders from stock.



QUICK-FIT

THE WORLD'S FASTEST DUCTING

ELBOWS

NOTE: Overall height calculation only works with 90° elbows.

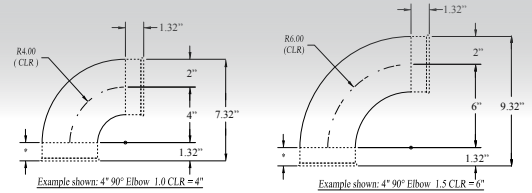

ELBOWS

Ø	PART NO.	ENDS	CLR	STYLE		GAUGE		TANGENTS	
				GALV	SS	GALV	SS	GALV	SS
90 DEGREE									
3"	3210-0390	QF	1.0*	P	T	24	14	2.25"	2.00"
4"-5"	3210-XX90	QF	1.0*	P	T	24	14	1.32"	2.00"
6"	3210-0690	QF	1.0*	P	T	24	14	1.32"	2.00"
7"	3210-0790	QF	1.0*	P	S	24	22	1.32"	2.25"
8"-12"	3210-XX90	QF	1.5	S	S	22	22	2.25"	2.25"
13"-24"	3210-XX90	QF	1.5	S	S	20	20	2.25"	2.25"
60 DEGREE									
3"	3210-0360	QF	1.0*	P	T	24	14	2.25"	2.00"
4"-5"	3210-XX60	QF	1.0*	P	T	24	14	1.32"	2.00"
6"	3210-0660	QF	1.0*	P	T	24	14	1.32"	2.00"
7"	3210-0760	QF	1.0*	P	S	24	22	1.32"	2.25"
8"-12"	3210-XX60	QF	1.5	S	S	22	22	2.25"	2.25"
13"-24"	3210-XX60	QF	1.5	S	S	20	20	2.25"	2.25"
45 DEGREE									
3"	3210-0345	QF	1.0*	P	T	24	14	2.25"	2.00"
4"-5"	3210-XX45	QF	1.0*	P	T	24	14	1.32"	2.00"
6"	3210-0645	QF	1.0*	P	T	24	14	1.32"	2.00"
7"	3210-0745	QF	1.0*	P	S	24	22	1.32"	2.25"
8"-12"	3210-0845	QF	1.5	S	S	22	22	2.25"	2.25"
13"-24"	3210-1345	QF	1.5	S	S	20	20	2.25"	2.25"
30 DEGREE									
3"	3210-0330	QF	1.0*	P	T	24	14	2.25"	2.00"
4"-5"	3210-XX30	QF	1.0*	P	T	24	14	1.32"	2.00"
6"	3210-0630	QF	1.0*	P	T	24	14	1.32"	2.00"
7"	3210-0730	QF	1.0*	P	S	24	22	1.32"	2.25"
8"-12"	3210-0830	QF	1.5	S	S	22	22	2.25"	2.25"
13"-24"	3210-1330	QF	1.5	S	S	20	20	2.25"	2.25"

T= Tubed style. CLR= Center Line radius. P= Press formed halves stitch welded together. S= Segmented elbows.

Notes: * 1.0 Galv and 1.5 SS

3" stainless steel elbows - constructed of 18ga walled tubing with collars spot welded and raised lap seamed on each end. This tube is airflow directional (collar on outside of tube for outlet and collar on inside of tube for inlet). Please specify direction if ordering ends other than QF.

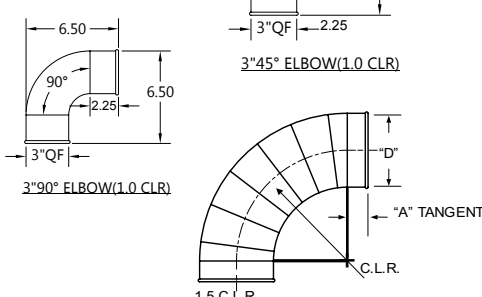
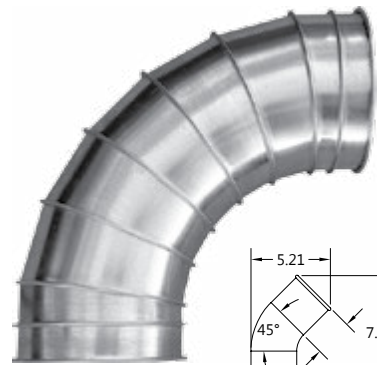
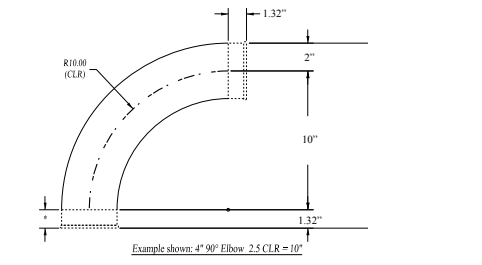

ELBOWS LONG RADIUS

Ø	PART NO.	ENDS	CLR	STYLE		GAUGE		TANGENTS	
				GALV	SS	GALV	SS	GALV	SS
90 DEGREE									
3"	3210-0390	QF	1.5*	P	T	24	14	2.00"	2.00"
4"-5"	3210-XX90	QF	1.5*	P	T	24	14	2.00"	2.00"
6"	3210-0690	QF	1.5*	P	T	24	14	2.00"	2.00"
7"	3210-0790	QF	1.5*	P	S	24	22	2.00"	2.25"
8"-12"	3210-0890	QF	2.5	S	S	22	22	2.25"	2.25"
13"-24"	3210-1390	QF	2.5	S	S	20	20	2.25"	2.25"
60 DEGREE									
3"	3210-0360	QF	1.5*	P	T	24	14	2.00"	2.00"
4"-5"	3210-XX60	QF	1.5*	P	T	24	14	2.00"	2.00"
6"	3210-0660	QF	1.5*	P	T	24	14	2.00"	2.00"
7"	3210-0760	QF	1.5*	P	S	24	22	2.00"	2.25"
8"-12"	3210-0860	QF	2.5	S	S	22	22	2.25"	2.25"
13"-24"	3210-1360	QF	2.5	S	S	20	20	2.25"	2.25"
45 DEGREE									
3"	3210-0345	QF	1.5*	P	T	24	14	2.00"	2.00"
4"-5"	3210-XX45	QF	1.5*	P	T	24	14	2.00"	2.00"
6"	3210-0645	QF	1.5*	P	T	24	14	2.00"	2.00"
7"	3210-0745	QF	1.5*	P	S	24	22	2.00"	2.25"
8"-12"	3210-0845	QF	2.5	S	S	22	22	2.25"	2.25"
13"-24"	3210-1345	QF	2.5	S	S	20	20	2.25"	2.25"
30 DEGREE									
3"	3210-0330	QF	1.5*	P	T	24	14	2.00"	2.00"
4"-5"	3210-XX30	QF	1.5*	P	T	24	14	2.00"	2.00"
6"	3210-0630	QF	1.5*	P	T	24	14	2.00"	2.00"
7"	3210-0730	QF	1.5*	P	S	24	22	2.00"	2.25"
8"-12"	3210-0830	QF	2.5	S	S	22	22	2.25"	2.25"
13"-24"	3210-1330	QF	2.5	S	S	20	20	2.25"	2.25"

T= Tubed style. CLR= Center Line radius. P= Press formed halves stitch welded together. S= Segmented elbows.

Notes: * 1.5 Galv and 2.5 SS

3" stainless steel elbows - constructed of 18ga walled tubing with collars spot welded and raised lap seamed on each end. This tube is airflow directional (collar on outside of tube for outlet and collar on inside of tube for inlet). Please specify direction if ordering ends other than QF.

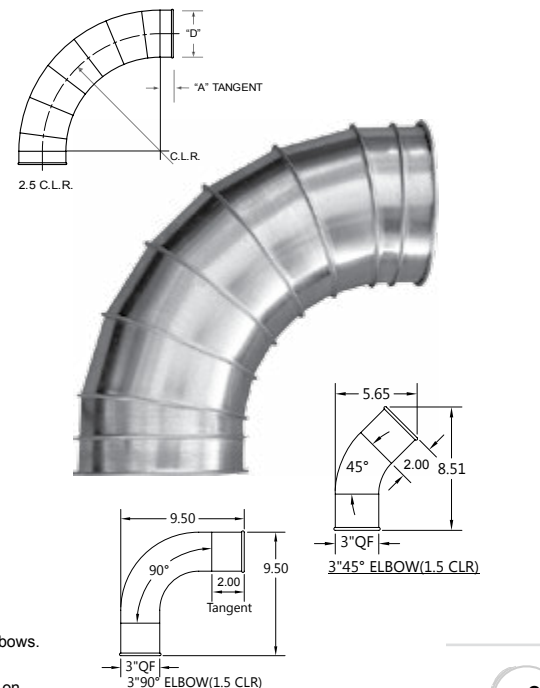

ELBOWS FLANGED ELBOWS LSB



QUICK-FIT
THE WORLD'S FASTEST DUCTING

ELBOW FLANGED

Ø	PART NO.	CLR		STYLE		GAUGE		TANGENTS
		GALV	SS	GALV	SS	GALV	SS	
90 DEGREE								
3"-6"	3211-0390	1	1.5	P	T	24	14	2"
7"	3211-0790	1	1.5	P	S	24	22	2"
8"-12"	3211-0890	1.5	1.5	S	S	22	22	2"
13"-15"	3211-1390	1.5	1.5	S	S	20	20	2"
16"-24"	3211-1690	1.5	1.5	S	S	20	20	4"
26"-32"	3211-2690	1.5	1.5	S	S	18	18	4"
34"-40"	3211-3490	1.5	1.5	S	S	16	16	4"
60 DEGREE								
3"-6"	3211-0360	1	1.5	P	T	24	14	2"
7"	3211-0760	1	1.5	P	S	24	22	2"
8"-12"	3211-0860	1.5	1.5	S	S	22	22	2"
13"-15"	3211-1360	1.5	1.5	S	S	20	20	2"
16"-24"	3211-1660	1.5	1.5	S	S	20	20	4"
26"-32"	3211-2660	1.5	1.5	S	S	18	18	4"
34"-40"	3211-3460	1.5	1.5	S	S	16	16	4"
45 DEGREE								
3"-6"	3211-0345	1	1.5	P	T	24	14	2"
7"	3211-0745	1	1.5	P	S	24	22	2"
8"-12"	3211-0845	1.5	1.5	S	S	22	22	2"
13"-15"	3211-1345	1.5	1.5	S	S	20	20	2"
16"-24"	3211-1645	1.5	1.5	S	S	20	20	4"
26"-32"	3211-2645	1.5	1.5	S	S	18	18	4"
34"-40"	3211-3445	1.5	1.5	S	S	16	16	4"
30 DEGREE								
3"-6"	3211-0330	1	1.5	P	T	24	14	2"
7"	3211-0730	1	1.5	P	S	24	22	2"
8"-12"	3211-0830	1.5	1.5	S	S	22	22	2"
13"-15"	3211-1330	1.5	1.5	S	S	20	20	2"
16"-24"	3211-1630	1.5	1.5	S	S	20	20	4"
26"-32"	3211-2630	1.5	1.5	S	S	18	18	4"
34"-40"	3211-3430	1.5	1.5	S	S	16	16	4"

T= Tubed style. CLR= Center Line radius. P= Press formed halves stitch welded together. S= Segmented elbows.

Notes: * 1.0 Galv and 1.5 SS

3" stainless steel elbows - constructed of 18ga walled tubing with collars spot welded and raised lap seamed on each end. This tube is airflow directional (collar on outside of tube for outlet and collar on inside of tube for inlet). Please specify direction if ordering ends other than QF.

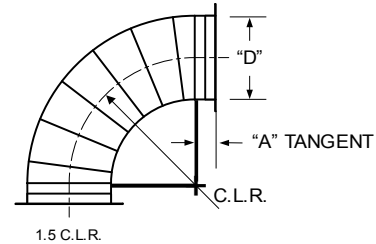

ELBOW HEAVY WALL

Ø	PART NO.	ENDS	TANGENT	CLR	GAUGE
90 DEGREE					
7"-24"	3212-XX90	QF	2.25"	2.5	16
60 DEGREE					
7"-24"	3212-XX60	QF	2.25"	2.5	16
45 DEGREE					
7"-24"	3212-XX45	QF	2.25"	2.5	16
30 DEGREE					
7"-24"	3212-XX30	QF	2.25"	2.5	16

Heavy wall are constructed of gores lapped over on another and spot welded. This tube is airflow directional (collar on outside of tube for outlet and collar on inside of tube for inlet). Please specify direction if ordering ends other than QF.

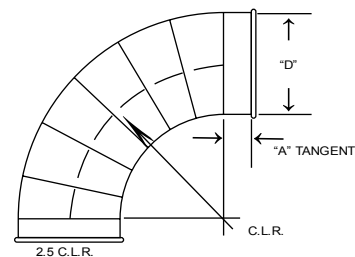

ELBOW TUBED

Ø	PART NO.	ENDS	CLR	GAUGE		TANGENTS	
				GALV	SS	GALV	SS
90 DEGREE							
3"	3214-0390	QF	1.5	16	14	2	2
4"	3214-0490	QF	1.5	16	14	2	2
5"	3214-0590	QF	1.5	14	14	2	2
6"	3214-0690	QF	1.5	14	14	2	2
8" ◊	3214-0890	QF	1.5	14	14	2	2
60 DEGREE							
3"	3214-0360	QF	1.5	16	14	2	2
4"	3214-0460	QF	1.5	16	14	2	2
5"	3214-0560	QF	1.5	14	14	2	2
6"	3214-0660	QF	1.5	14	14	2	2
8"	3214-0860	QF	1.5	14	14	2	2
45 DEGREE							
3"	3214-0345	QF	1.5	16	14	2	2
4"	3214-0445	QF	1.5	16	14	2	2
5"	3214-0545	QF	1.5	14	14	2	2
6"	3214-0645	QF	1.5	14	14	2	2
8"	3214-0845	QF	1.5	14	14	2	2
30 DEGREE							
3"	3214-0330	QF	1.5	16	14	2	2
4"	3214-0430	QF	1.5	16	14	2	2
5"	3214-0530	QF	1.5	14	14	2	2
6"	3214-0630	QF	1.5	14	14	2	2
8"	3214-0830	QF	1.5	14	14	2	2

◊ Items may take longer than standard lead times.

This tube is airflow directional (collar on outside of tube for outlet and collar on inside of tube for inlet). Please specify direction if ordering ends other than QF.

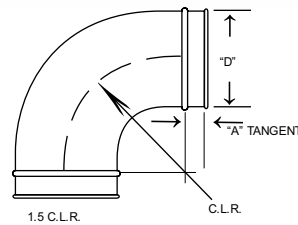

ELBOW TUBED LONG RADIUS

Ø	PART NO.	ENDS	CLR	GAUGE		TANGENTS	
				GALV	SS	GALV	SS
90 DEGREE							
3"	3214-0390LR	QF	2.5	16	14	2	2
4"	3214-0490LR	QF	2.5	16	14	2	2
5"	3214-0590LR	QF	2.5	14	14	2	2
6"	3214-0690LR	QF	2.5	14	14	2	2
8" ◊	3214-0890LR	QF	2.5	14	14	2	2
60 DEGREE							
3"	3214-0360LR	QF	2.5	16	14	2	2
4"	3214-0460LR	QF	2.5	16	14	2	2
5"	3214-0560LR	QF	2.5	14	14	2	2
6"	3214-0660LR	QF	2.5	14	14	2	2
8"	3214-0860LR	QF	2.5	14	14	2	2
45 DEGREE							
3"	3214-0345LR	QF	2.5	16	14	2	2
4"	3214-0445LR	QF	2.5	16	14	2	2
5"	3214-0545LR	QF	2.5	14	14	2	2
6"	3214-0645LR	QF	2.5	14	14	2	2
8"	3214-0845LR	QF	2.5	14	14	2	2
30 DEGREE							
3"	3214-0330LR	QF	2.5	16	14	2	2
4"	3214-0430LR	QF	2.5	16	14	2	2
5"	3214-0530LR	QF	2.5	14	14	2	2
6"	3214-0630LR	QF	2.5	14	14	2	2
8"	3214-0830LR	QF	2.5	14	14	2	2

◊ Items may take longer than standard lead times.

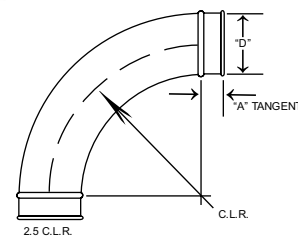

MACHINE ADAPTER

Ø	PART NO.	RAW END ID	RAW END OD	GAUGE	APPROX. LENGTH	MAXIMUM OPEN DIM. ID
3"	3249-0300	2.90"	3.00"	22	5.5"	3.18"
4"	3249-0400	3.86"	3.93"	22	4"	4.30"
5"	3249-0500	4.87"	4.94"	22	4"	5.30"
6"	3249-0600	5.89"	5.96"	22	4"	6.30"
7"	3249-0700	6.89"	6.96"	22	4"	7.30"
8"	3249-0800	7.88"	7.95"	22	4"	8.30"
9"	3249-0900	8.88"	8.95"	22	4"	9.30"
10"	3249-1000	9.89"	9.95"	22	4"	10.30"
11"	3249-1100	10.88"	10.94"	22	4"	11.30"
12"	3249-1200	11.97"	12.04"	22	4"	12.30"
13"	3249-1300	12.97"	13.05"	20	5.5"	13.30"
14"	3249-1400	13.96"	14.04"	20	5.5"	14.30"
15"	3249-1500	14.97"	15.04"	20	5.5"	15.30"
16"	3249-1600	15.97"	16.04"	20	5.5"	16.30"
17"	3249-1700	16.97"	17.05"	20	5.5"	17.30"
18"	3249-1800	17.96"	18.04"	20	5.5"	18.30"
20"	3249-2000	19.96"	20.04"	20	5.5"	20.30"
22"	3249-2200	21.97"	22.05"	20	5.5"	22.30"
24"	3249-2400	23.94"	24.02"	20	5.5"	24.30"

Attach this adapter to your machine's dust port and you'll be able to connect your entire system with the fast and easy QF Clamp.

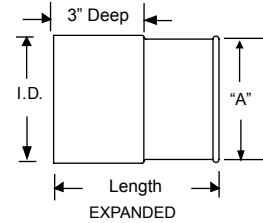
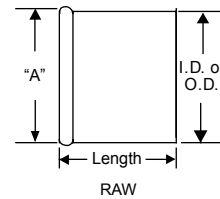

ANGLE FLANGE ADAPTER

Ø	PART NO.	APPROX. LENGTH	GAUGE
3"	3250-0300	5"	22
4"-12"	3250-XX00	3.5"	22
13"-24"	3250-XX00	5"	20

Attach this adapter to your machine's dust port and you'll be able to connect your entire system with the fast and easy QF Clamp.

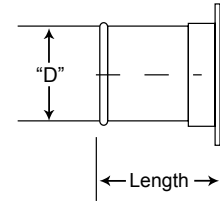

HOSE ADAPTER

Ø	PART NO.	APPROX. LENGTH	GAUGE
3"	3282-0300	5.5"	22
4"-12"	3282-XX00	4"	22
13"-24"	3282-XX00	5.5"	20

With the QF Hose adapter, you only need to fight cumbersome "worm-style" hose clamps once, then just use the QF clamp.

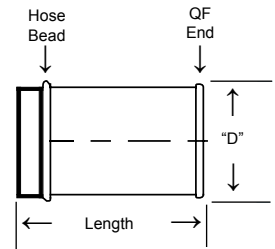

BELL MOUTH ADAPTER

Ø (A)	Ø (B)	PART NO.	LENGTH (L)
3"	8"	3251-0300	4.5"
4"	9"	3251-0400	4.5"
5"	10"	3251-0500	4.5"
6"	12"	3251-0600	5.0"
7"	13"	3251-0700	5.0"
8"	14"	3251-0800	5.0"
9"	15"	3251-0900	5.0"
10"	16"	3251-1000	5.0"
11"	19"	3251-1100	6.0"
12"	20"	3251-1200	6.0"
13"	21"	3251-1300	6.0"
14"	22"	3251-1400	6.0"
15"	23"	3251-1500	6.0"
16"	26"	3251-1600	7.0"
17"	27"	3251-1700	7.0"
18"	28"	3251-1800	7.0"
20"	30"	3251-2000	7.0"
22"	34"	3251-2200	8.0"
24"	36"	3251-2400	8.0"

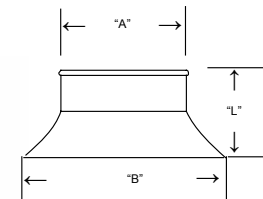

This flared end adapter dramatically beats a straight pipe at collecting dust mist and fume collection by increasing the capture ratio.

*All branches priced by large end.

BRANCH

Ø	PART NO.	ENDS	GAUGE	
			GALV	SS
3"-12"	3220-YYXX	QF	22	22
13"-24"	3220-YYXX	QF	20	20
26"-40"	3220-YYXX	FLANGE	18	18

- Standard 30° Optional 45°.
- 26"-40" A is flanged.
- When ordering specify A, B, C.
- $A - B \geq B - C$
- Use formula above to determine if a reducer is needed at "C".

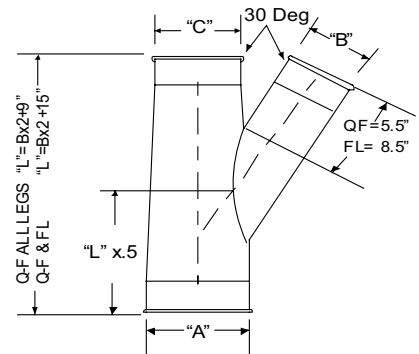

Y BRANCH

Ø	PART NO.	ENDS	GAUGE	
			GALV	SS
3"-12"	3221-YYXX	QF	22	22
13"-24"	3221-YYXX	QF	20	20
26"-40"	3221-YYXX	FLANGE	18	18

- Standard 60° Optional 90°.
- 26"-40" A is flanged.
- When ordering specify A, B, D.
- Both B & D must be at least 50% of A. With B or D being 80% of the opposite leg
- Flange Leg: Length = 4.5"
Height = $A + 4$ "

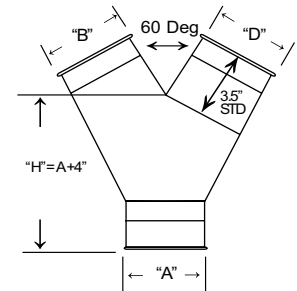

DOUBLE BRANCH

Ø	PART NO.	ENDS	GAUGE	
			GALV	SS
3"-12"	3226-YYXX	QF	22	22
13"-24"	3226-YYXX	QF	20	20
26"-40"	3226-YYXX	FLANGE	18	18

- Standard 30° Optional 45°.
- 26"-40" A is flanged.
- When ordering specify A, B, C, D.
- $(A - B) \geq (B - C)$ and $(B) \geq (D)$
- Reducer at "B" or "D" may be required. Use formula above to determine.

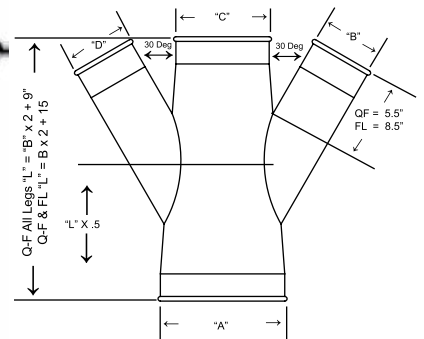

T-BRANCH

Ø	PART NO.	ENDS	GAUGE	
			GALV	SS
3"-12"	3227-YYXX	QF	22	22
13"-24"	3227-YYXX	QF	20	20
26"-40"	3227-YYXX	FLANGE	18	18

- When ordering specify A, B.
- 26"-40" A1 is flanged.
- "A1" to "A2" must be the same dimension, however "B" must be equal to or smaller than the "A" dimensions.

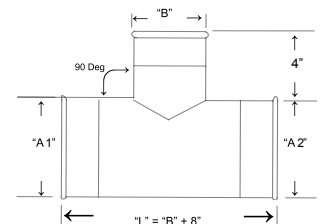

QF IN-CUT QF TAP-IN END CAPS REDUCER



QUICK-FIT
THE WORLD'S FASTEST DUCTING

IN CUT

Ø	PART NO.	ENDS	GAUGE	
			GALV	SS
3"-12"	3223-XXYY	QF	22	22
13"-24"	3223-XXYY	QF	20	20
26"-40"	3223-XXYY	FLANGE	18	18

In Cut used to cut into existing lines to begin QF system. Standard end is QF.

*XX = A dimension, YY = B dimension. Gauge based on "A"

Standard 30° Optional 45°.

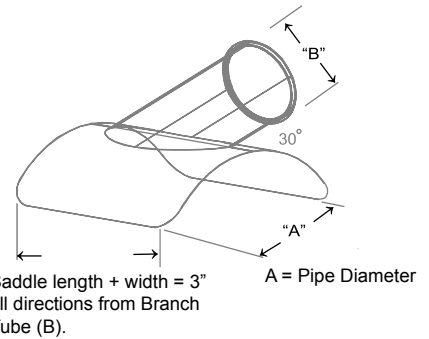

TAP IN

Ø	PART NO.	ENDS	GAUGE	
			GALV	SS
3"-12"	3224-XXYY	QF	22	22
13"-24"	3224-XXYY	QF	20	20
26"-40"	3224-XXYY	FLANGE	18	18

Tap In used to cut into existing lines to begin QF system. Standard end is QF.

*XX = A dimension, YY = B dimension. Gauge based on "A"

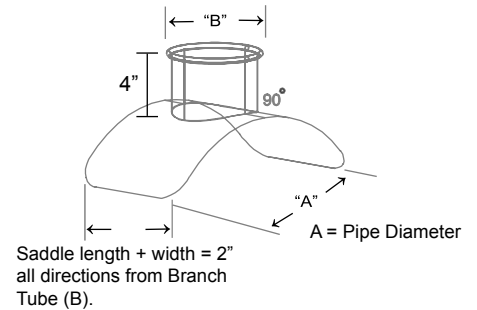

END CAP

Ø	PART NO.	ENDS	GAUGE	
			GALV	SS
3"	3151-XX00	QF	18	18
4"-12"	3151-XX00	QF	22	22
13"-24"	3151-XX00	QF	20	20

End caps connect easily with the QF clamp and are used to cap-off an unused ducting port. They are ideal for future expansion or when a machine has been moved.

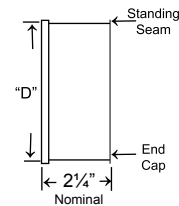

END CAP WITH BIRD SCREEN

Ø	PART NO.	ENDS	GAUGE	
			GALV	SS
3"	3152-XX00	QF	18	18
4"-12"	3152-XX00	QF	22	22
13"-24"	3152-XX00	QF	20	20

End caps with bird screen connect easily with the QF Clamp and are used in situations where openings are needed to allow air to enter or exit a system. The bird screen keeps foreign objects from entering the system.

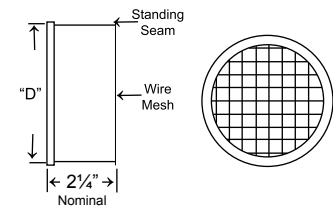

REDUCER

Ø	PART NO.	ENDS	GAUGE	
			GALV	SS
3"-15"	3222-03XX	QF	22	22
16"-24"	3222-16XX	QF	20	20
26"-40"	3222-26XX	FLANGE	18	18

• 26"-40" A is flanged.

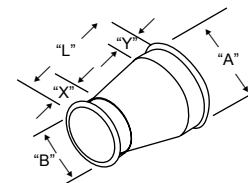

- Priced by large end 'A'.
- When ordering specify A,B.
- Specify reducer end style.
"X" & "Y" are standard 2" long nominal.
QF length (L) = A-B+6", 7" min.
FL length (L) = A-B+8", 9" min.



QUICK-FIT
THE WORLD'S FASTEST DUCTING

**TRANSITIONS
ROUTER HOODS
BALL JOINT
SUCTION HOOD**

TRANSITION RECTANGULAR TO ROUND*

Ø	PART NO.	ENDS
3"-24"	3225-03XX	QF
26"-40"	3225-26XX	FLANGE

* Priced by largest area of opening. Round end (D) or Square area for rectangular end (A x B = SQ area).

*Angle Flange cost not included in price.

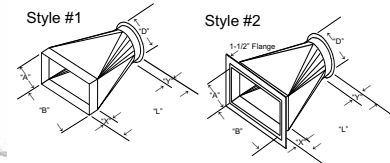

*NOTE: Minimum L = .75 (B). If less, square to square transition will be provided.



ROUTER HOOD

Ø	PART NO.	ENDS
3"-10"	3231-XX00	QF

Designed specifically to collect dust from a router. Connects quickly and easily with the QF Clamp.



ROUTER HOOD WITH MAGNET

Ø	PART NO.	ENDS
3"-10"	3232-XX00	QF

Designed specifically to collect dust from a router. The magnet holds the hood in position. Connects quickly and easily with the QF Clamp. Standard opening 6" x 12".

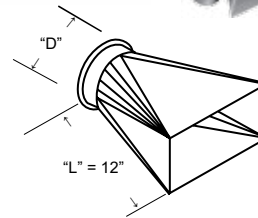

BALL JOINT

Ø	PART NO.	ENDS	LENGTH (L)	GAUGE
3"	3209-0300	QF	8	20
4"	3209-0400	QF	9.5	20
5"	3209-0500	QF	10.75	20
6"	3209-0600	QF	11.75	20
7"	3209-0700	QF	10.75	20
8"	3209-0800	QF	14	18
9"	3209-0900	QF	15	18
10"	3209-1000	QF	14.25	18
12"	3209-1200	QF	15.25	16
14"	3209-1400	QF	17.5	14

Allows 22-degrees of movement off-center. Perfect for machines with moving dust ports.

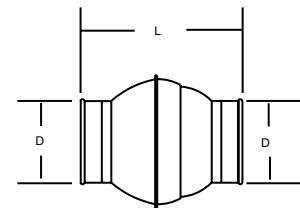

SUCTION HOOD

PART NO.	ENDS	NO. OF PICK-UPS
3230-XX02	QF	2
3230-XX03	QF	3
3230-XX04	QF	4
3230-XX05	QF	5
3230-XX06	QF	6

Available round or rectangular.

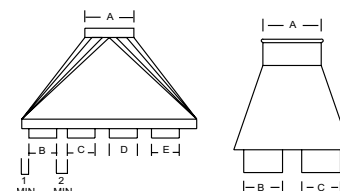

BLAST GATE NFES AUTOMATIC

Ø	PART NO.	ENDS	(A) INCH	(B) INCH	(C) INCH	(D) INCH
3"	3245-0300	QF	16.00	6.38	5.50	5.50
4"	3245-0400	QF	16.00	6.30	5.50	5.11
5"	3245-0500	QF	17.50	7.50	5.25	6.00
6"	3245-0600	QF	20.50	8.66	5.25	7.00
7"	3245-0700	QF	22.00	9.44	5.25	7.25
8"	3245-0800	QF	25.50	10.25	5.25	8.25
9"	3245-0900	QF	33.00	17.36	9.00	14.17
10"	3245-1000	QF	33.00	17.36	9.00	14.17
12"	3245-1200	QF	38.50	20.00	9.00	15.50
14"	3245-1400	QF	41.00	23.30	12.00	16.00
16" ◊	3245-1600	QF	45.00	23.30	12.00	17.12
18" ◊	3245-1800	QF	48.50	25.25	12.00	18.00
20" ◊	3245-2000	QF	52.50	27.20	12.00	19.00
22" ◊	3245-2200	QF	57.50	29.50	12.00	20.27

Uses 120 volt control and 75 psi of air pressure to shut off airflow from machines not in use, improving suction elsewhere in the system, and energy efficiency.

◊ Items may take longer than standard lead times.

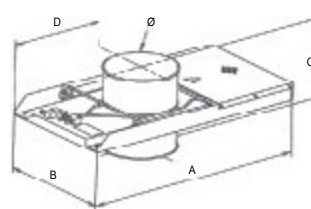
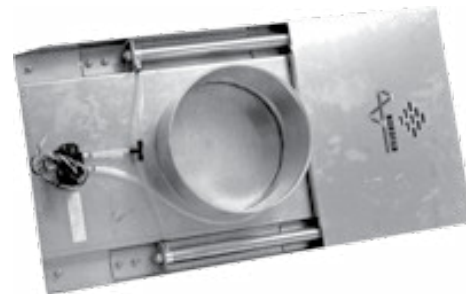

SINGLE CYLINDER
3" to 8"

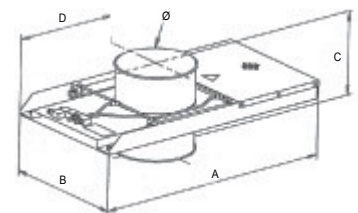

TWO CYLINDER
9" to 22"

SD AUTOMATIC BLAST GATE

Ø	PART NO.	ENDS	(A) INCH	(B) INCH	(C) INCH	(D) INCH	(E) INCH
3"	3242-0300	QF	8.11	4.25	5.25	6.30	8.5
4"	3242-0400	QF	10.31	5.30	5.50	7.81	8.5
5"	3242-0500	QF	12.80	6.00	5.75	9.88	9.5
6"	3242-0600	QF	14.47	7.12	5.75	11.28	11.5
7"	3242-0700	QF	16.25	8.00	5.38	12.44	11.5
8"	3242-0800	QF	18.75	9.30	5.50	14.38	13.5
9"	3242-0900	QF	20.63	10.63	5.50	15.88	13.5
10"	3242-1000	QF	22.63	11.65	5.50	17.25	13.5
12"	3242-1200	QF	30.00	16.00	5.25	23.25	N/A
14"	3242-1400	QF	33.04	18.38	5.25	25.29	N/A
16" ◊	3242-1600	QF	38.52	20.38	11.25	29.65	N/A
18" ◊	3242-1800	QF	46.69	22.38	11.25	37.04	N/A
20" ◊	3242-2000	QF	48.69	24.38	11.25	38.04	N/A
22" ◊	3242-2200	QF	50.69	26.38	11.25	39.04	N/A
24" ◊	3242-2400	QF	55.50	31.28	11.25	42.40	N/A

Uses 120 volt control and 75 psi of air pressure to shut off airflow from machines not in use, improving suction elsewhere in the system, and energy efficiency.

◊ Items may take longer than standard lead times.

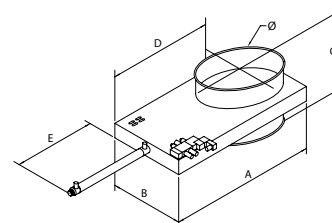

SINGLE CYLINDER
3" to 10"

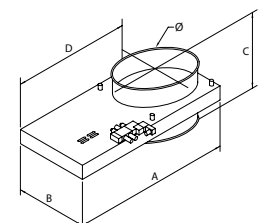

TWO CYLINDER
12" to 24"

SS Blast Gates have a minimum lead time of 7 days



QUICK-FIT

THE WORLD'S FASTEST DUCTING

BLAST GATE NFMES MANUAL

Ø	PART NO.	ENDS	GALV WIDTH	GALV HEIGHT	GALV DEPTH
3"	3241-0300	QF	5.25	7.00	5.375
4"	3241-0400	QF	6.12	6.25	5.375
5"	3241-0500	QF	7.00	10.00	5.00
6"	3241-0600	QF	8.00	11.12	5.00
7"	3241-0700	QF	9.37	12.00	5.00
8"	3241-0800	QF	11.00	13.25	5.00
9"	3241-0900	QF	11.37	14.37	5.00
10"	3241-1000	QF	13.50	16.25	5.00
12"	3241-1200	QF	15.75	17.87	5.00
14"	3241-1400	QF	18.00	28.50	5.00
16" ◊	3241-1600	QF	18.00	28.50	5.00

Shuts off airflow from machines not in use, improving suction elsewhere in the system, and energy efficiency. Heavy-duty seals help to prevent leakage from around the closed gate.

◊ Items may take longer than standard lead times.

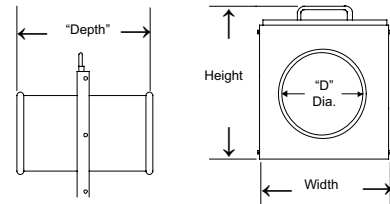

BLAST GATE MANUAL

Ø	PART NO.	ENDS	GALV. WIDTH	GALV. HEIGHT	GALV. DEPTH	SS WIDTH	SS HEIGHT	SS DEPTH
3"	3240-0300	QF	4.25	7.00	5.25	5.00	6.00	5.25
4"	3240-0400	QF	5.25	7.00	5.50	6.00	7.50	5.25
5"	3240-0500	QF	6.12	6.25	5.75	7.00	10.50	5.00
6"	3240-0600	QF	7.00	10.00	5.75	8.00	11.00	5.00
7"	3240-0700	QF	8.00	11.12	5.38	9.00	12.00	5.00
8"	3240-0800	QF	9.37	12.00	5.50	10.00	13.50	5.00
9"	3240-0900	QF	11.00	13.25	5.50	11.00	15.00	5.00
10"	3240-1000	QF	11.37	14.37	5.50	12.00	17.00	5.00
11" ◊	3240-1100	QF	11.37	14.37	5.50	13.00	19.00	5.00
12"	3240-1200	QF	13.50	16.25	5.25	14.00	20.50	5.00
14"	3240-1400	QF	15.75	17.87	5.25	16.00	23.25	5.00
16" ◊	3240-1600	QF	18.00	28.50	11.25	CALL	CALL	CALL
18" ◊	3240-1800	QF	20.80	32.75	11.25	CALL	CALL	CALL
20" ◊	3240-2000	QF	22.25	34.00	11.25	CALL	CALL	CALL
22" ◊	3240-2200	QF	24.25	33.50	11.25	CALL	CALL	CALL
24" ◊	3240-2400	QF	26.25	33.50	11.25	CALL	CALL	CALL
26" ◊	3240-2600	FLANGE	29.25	47.50	CALL	CALL	CALL	CALL
28" ◊	3240-2800	FLANGE	30.25	47.50	CALL	CALL	CALL	CALL
30" ◊	3240-3000	FLANGE	33.25	55.75	CALL	CALL	CALL	CALL

Shuts off airflow from machines not in use, improving suction elsewhere in the system, and energy efficiency.

◊ Items may take longer than standard lead times.

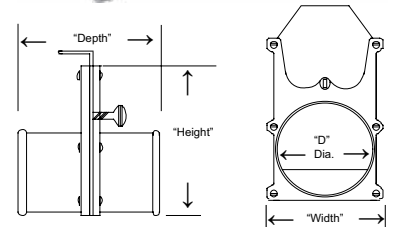

SS Blast Gates have a minimum lead time of 7 days

HOSE HOSE CLAMP



QUICK-FIT
THE WORLD'S FASTEST DUCTING

RUBBER HOSE

Ø	PART NO.
1"	3280-0100
1.5"	3280-1500
2"	3280-0200
2.5"	3280-2500
3"	3280-0300
3.5"	3280-3500
4"	3280-0400
5"	3280-0500
5.5"	3280-5500
6"-24"	3280-XX00

- Clear FDA approved hose is also available.
- #3282 Hose Adapter recommended with this hose.
- Sold by the foot in 5' increments.



RIGID FLEX STEEL HOSE

Ø	PART NO.
1.5"	3281-1500
2"	3281-0200
2.5"	3281-2500
3"	3281-0300
3.5"	3281-3500
4"-14"	3281-XX00

- SS available upon request
- Sold by the foot in 5' sections only.
- 1.5" - 6" can be sold at any length.
- 7" - 14" is sold by the foot in 5' sections only.

NOTE: Ends and adapters must be welded onto steel hose as standard "worm clamps" will not work.



- Do **NOT** use #3285 SS Hose Clamps with these hoses (3281 & 3282). Alternate ends are available for these hoses upon request at additional cost of \$10.00 per end plus the cost of a machine adapter. If flange required, see pg. 8.

ULTRA FLEX STEEL HOSE

Ø	PART NO.
3"-8"	3283-XX00

- SS available upon request
- Sold by the foot in 5' increments.
- 3" - 6" can be sold at any length.
- 7" - 8" is sold by the foot in 5' sections only.

NOTE: Ends and adapters must be welded onto steel hose as standard "worm clamps" will not work.



HOSE CLAMP

Ø	PART NO.
2"-24"	3285-XX00

Standard hose clamps are used to connect rubber and FDA hoses to QF hose adapters. From that point, hoses can be easily detached and re-attached.



- Stainless Steel only

MANUAL DIVERTER VALVE

Ø	PART NO.	ENDS	D	B	A	L	HOUSING GAUGE
3"	3235-0345	QF	3"	14"	6"	26"	3/16"
4"	3235-0445	QF	4"	14"	6"	26"	3/16"
5"	3235-0545	QF	5"	15.25"	6"	27.25"	3/16"
6"	3235-0645	QF	6"	16"	6"	28"	3/16"
7"	3235-0745	QF	7"	16"	6"	28"	3/16"
8"	3235-0845	QF	8"	17"	6"	29"	3/16"
9"	3235-0945	QF	9"	18"	8"	34"	3/16"
10"	3235-1045	QF	10"	20"	8"	36"	3/16"
11"	3235-1145	QF	11"	20"	8"	36"	3/16"
12"	3235-1245	QF	12"	24"	8"	40"	3/16"
13"	3235-1345	QF	13"	24"	8"	40"	3/16"
14"	3235-1445	QF	14"	28"	8"	44"	3/16"
15"	3235-1545	QF	15"	28"	8"	44"	3/16"
16"	3235-1645	QF	16"	32"	8"	48"	3/16"
17"	3235-1745	QF	17"	32"	8"	48"	3/16"
18"	3235-1845	QF	18"	36"	8"	52"	3/16"
20"	3235-2045	QF	20"	40"	10"	60"	3/16"
22"	3235-2245	QF	22"	41.25"	10"	61.25"	3/16"
24"	3235-2445	QF	24"	48"	10"	68"	3/16"

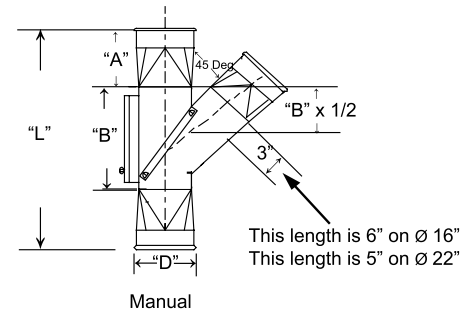

Very heavy-duty, efficient and economical method of diverting the flow of material or air. Connects quickly and easily with the QF Clamp. 45° angle only.

AUTOMATIC DIVERTER VALVE

Ø	PART NO.	ENDS	D	B	A	L	HOUSING GAUGE
3"	3236-0345	QF	3"	14"	6"	26"	3/16"
4"	3236-0445	QF	4"	14"	6"	26"	3/16"
5"	3236-0545	QF	5"	15.25"	6"	27.25"	3/16"
6"	3236-0645	QF	6"	16"	6"	28"	3/16"
7"	3236-0745	QF	7"	16"	6"	28"	3/16"
8"	3236-0845	QF	8"	17"	6"	29"	3/16"
9"	3236-0945	QF	9"	18"	8"	34"	3/16"
10"	3236-1045	QF	10"	20"	8"	36"	3/16"
11"	3236-1145	QF	11"	20"	8"	36"	3/16"
12"	3236-1245	QF	12"	24"	8"	40"	3/16"
13"	3236-1345	QF	13"	24"	8"	40"	3/16"
14"	3236-1445	QF	14"	28"	8"	44"	3/16"
15"	3236-1545	QF	15"	28"	8"	44"	3/16"
16"	3236-1645	QF	16"	32"	8"	48"	3/16"
17"	3236-1745	QF	17"	32"	8"	48"	3/16"
18"	3236-1845	QF	18"	36"	8"	52"	3/16"
20"	3236-2045	QF	20"	40"	10"	60"	3/16"
22"	3236-2245	QF	22"	41.25"	10"	61.25"	3/16"
24"	3236-2445	QF	24"	48"	10"	68"	3/16"

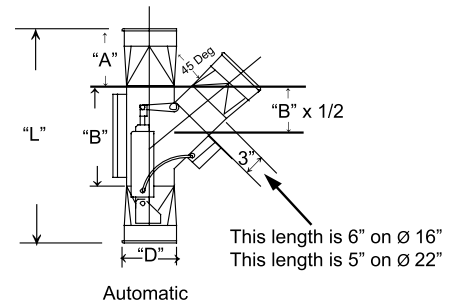

Very heavy-duty, efficient and economical method of diverting the flow of material or air. Uses 120V control and opens and closes using 75 psi air pressure. Connects quickly and easily with the QF Clamp. 45° angle only.

SD MANUAL DIVERTER VALVE

Ø	PART NO.
3"	3233-0300
4"	3233-0400
5"	3233-0500
6"	3233-0600
7"	3233-0700
8"	3233-0800
9"	3233-0900
10"	3233-1000
11"	3233-1100
12"	3233-1200
13"	3233-1300

SD AUTOMATIC DIVERTER VALVE

Ø	PART NO.
3"	3234-0300
4"	3234-0400
5"	3234-0500
6"	3234-0600
7"	3234-0700
8"	3234-0800
9"	3234-0900
10"	3234-1000
11"	3234-1100
12"	3234-1200
13"	3234-1300

45° angle only.

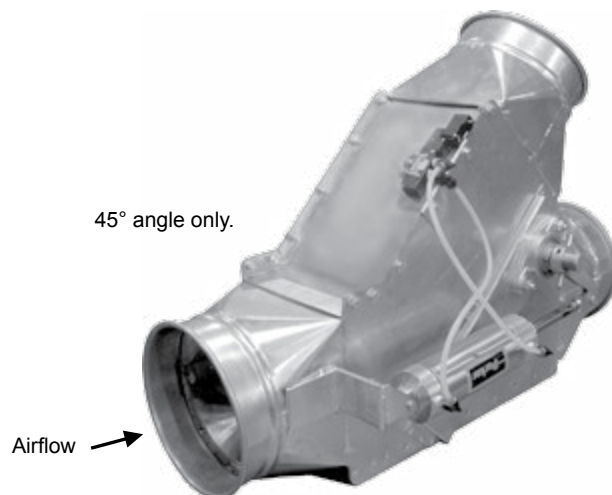

All Diverters have a 7 day lead time minimum

**PIPE HANGER
PIPE HANGER HJ
GRIPPLE HANGER
STRUT HANGER
PIPE BRACING
BEAM CLAMP**



QUICK-FIT
THE WORLD'S FASTEST DUCTING

PIPE HANGER

Ø	PART NO.
3"-40"	3265-XX00

*Make sure to check your local codes to ensure your ducting is properly supported.
Clearance hole 5/16"

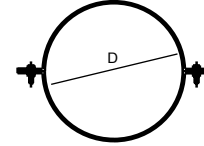

PIPE HANGER HJ

Ø	PART NO.
3"-24"	3265-XX00-1HJ

*Make sure to check your local codes to ensure your ducting is properly supported.
Clearance hole 7/16"

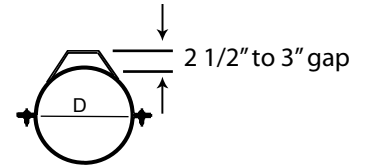

GRIPPLE HANGER

SIZE WEIGHT	PART NO.
Up to 22lbs	3266-1500-022LBS
Up to 100lbs	3266-1500-100LBS
Up to 200lbs	3266-1500-200LBS
Up to 495lbs	3266-1500-495LBS
Up to 715lbs	3266-1500-715LBS

Supplied in 15' lengths.

*Make sure to check your local codes to ensure your ducting is properly supported.

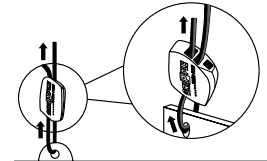

STRUT HANGER

Ø	PART NO.
3"-24"	3265-XX00-1mh

Tested by MET Laboratories to hold up to 170lbs for 9" pipe and up to 850lbs for 20" without failure.

*Make sure to check your local codes to ensure your ducting is properly supported.
Nut and bolt included.



PIPE BRACING

Ø	PART NO.
1/2"	3268-0100

It is supplied in 10' lengths and not drilled or flattened.

*Make sure to check your local codes to ensure your ducting is properly supported.



BEAM CLAMP

OPENNING	PART NO.
3/4"	3269-0100

Speed up connection of pipe bracing to building steel members. It has a 3/8" - 16 Thread style.

*Make sure to check your local codes to ensure your ducting is properly supported.

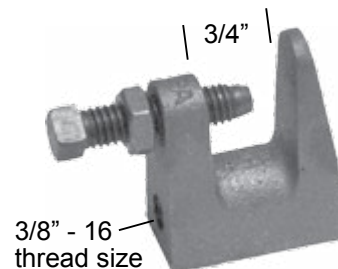

LEAK-FREE SYSTEM

Nordfab's leak free system consists of three parts: Gaskets, O-rings, and Epoxy Caulking

LEAK-FREE MOLDED GASKET

Ø	PART NO.
4"-10"	3190-XX00
12"	3190-1200
14"	3190-1400
16"	3190-1600
18"	3190-1800
20"	3190-2000
22"	3190-2200
24"	3190-2400

Classification: 1. ASTM D-2000 M2BG510 A24 B34 E014
EO34 EF11 EF21

Temp range -30°F to +225°F

No additional sizes available

LEAK-FREE O-RING

Ø	PART NO.
4"-24"	3191-XX00

Classification: 1. ASTM D-1056-68.....SBE43
2. ASTM D-1056-85, 91, 98.....2B3

Temp range -30°F to +225°F

These materials work in conjunction with Nordfab's standard O-ring. IT DOES NOT REPLACE IT.

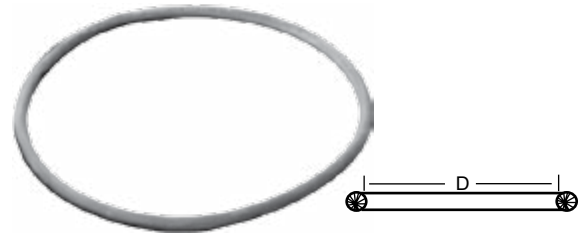
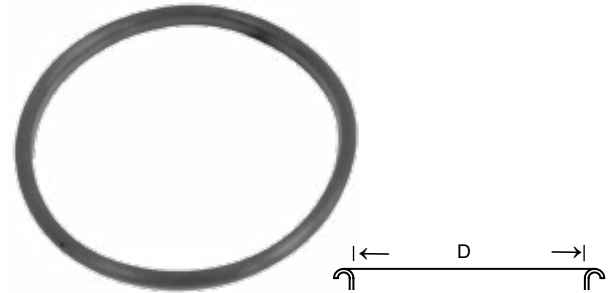

LEAK-FREE EPOXY CAULKING IS AVAILABLE ON ALL NON-LASER WELDED PARTS.



A leak-free duct system is largely dependent on the skill and care of the installer, so Nordfab cannot guarantee a 100% leak free system. However, if users consult the technical data (to ensure that our gasket and sealing materials will stand up to the materials being conveyed) and take care in the installation process, this system has proven that it can be 'Leak Free'.

TUFF SHIELD ABRASION RESISTANT LINING

TUFF SHIELD ABRASION RESISTANT LINING IS AVAILABLE ON REDUCERS, BRANCHES, ELBOWS AND EXTENDERS.



Please allow 3 weeks for production of all TS parts

FLOOR SWEEP IN-LINE BACK BLAST DAMPER



QUICK-FIT
THE WORLD'S FASTEST DUCTING

FLOOR SWEEP

Ø	PART NO.	ENDS	A INCH	B INCH	C INCH	L INCH
3"-12"	3248-XX00	QF	6"	12"	3.5"	18"

Connect this "self-vacuuming dust pan" to your existing dust collection system with the quick and easy QF Clamp.

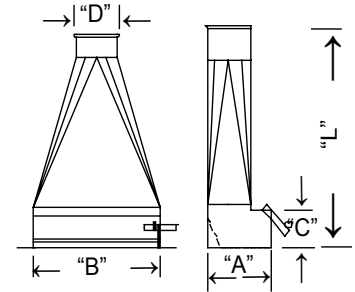

IN LINE BACK DRAFT DAMPER

Ø	PART NO.	ENDS	LENGTH (L)	LENGTH (B)	GAUGE
3"	3219-0300	QF	17.5"	7"	18
4"	3219-0400	QF	18.5"	7"	18
5"	3219-0500	QF	19.5"	7"	18
6"	3219-0600	QF	20.5"	7"	18
7"	3219-0700	QF	21.5"	7"	18
8"	3219-0800	QF	22.5"	7"	18
9"	3219-0900	QF	23.5"	7"	18
10"	3219-1000	QF	24.5"	7"	18
11"	3219-1100	QF	25.5"	7"	18
12"	3219-1200	QF	26.5"	7"	18
13"	3219-1300	QF	32.5"	12"	18
14"	3219-1400	QF	33.5"	12"	18
15"	3219-1500	QF	34.5"	12"	18
16"	3219-1600	QF	43.5"	20"	18
17"	3219-1700	QF	44.5"	20"	18
18"	3219-1800	QF	45.5"	20"	18
20"	3219-2000	QF	47.5"	20"	16
22"	3219-2200	QF	49.5"	20"	16
24"	3219-2400	QF	51.5"	20"	16
26"	3219-2600	FLANGE	57.5"	24"	16
28"	3219-2800	FLANGE	59.5"	24"	16
30"	3219-3000	FLANGE	61.5"	24"	16
32"	3219-3200	FLANGE	63.5"	24"	16
34"	3219-3400	FLANGE	65.5"	24"	16

Used to prevent backwards air flow in a horizontal line. Connects quickly and easily with the QF Clamp.

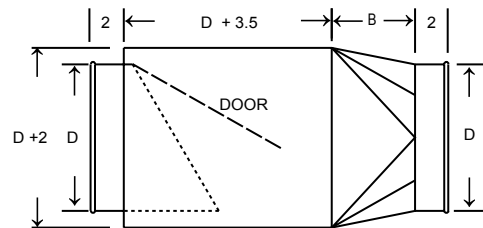



QUICK-FIT

THE WORLD'S FASTEST DUCTING

**VIBRATION ISOLATOR
NO LOSS STACKHEAD
CUSTOM MANIFOLD**

VIBRATION ISOLATOR

Ø	PART NO.	ENDS	LENGTH (L)	GAUGE
3"	3206-0300	QF	6.5	24
4"-12"	3206-XX00	QF	6.5	22
13"-22"	3206-XX00	QF	6.5	20
24"	3206-2400	QF	7	20
26"-30"	3206-XX00	FLANGE	10	18
32"-40"	3206-XX00	FLANGE	10	18

Inhibits vibrations from passing from the fan into the ducting system.

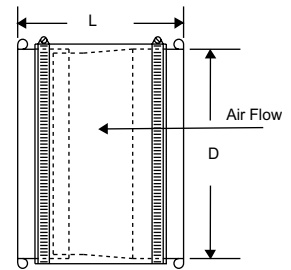

NO-LOSS STACKHEAD

Ø	PART NO.	ENDS	GAUGE
3"	3204-0300	QF	24
4"-12"	3204-XX00	QF	22
13"-24"	3204-XX00	QF	20
26"-28"	3204-XX00	FLANGE	20
30"-40"	3204-XX00	FLANGE	18

Replaces the traditional "china hats" for exhausting through a roof -- without allowing rainwater to enter or adding significant backpressure.

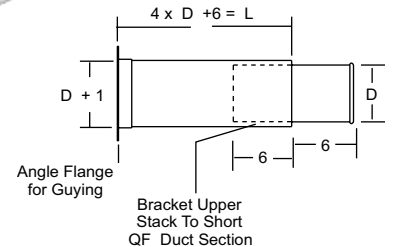
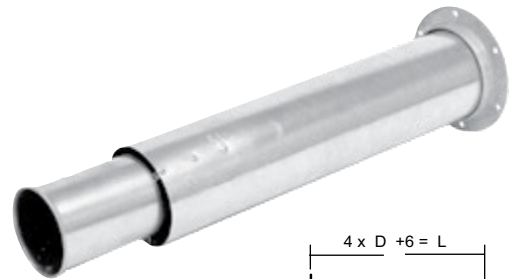

JET CAP

Ø	PART NO.	ENDS	W (INCHES)	H (INCHES)	GAUGE GALV/SS
6"	3258-0600	QF	10.12	14.4	22
8"	3258-0800	QF	13.25	18.4	22
10"	3258-1000	QF	16.5	22.4	22
12"	3258-1200	QF	20	27	22
13"	3258-1300	QF	21.5	30	20
14"	3258-1400	QF	23.12	32.8	20
15"	3258-1500	QF	24.5	34	20
16"	3258-1600	QF	26.5	36.4	20
17"	3258-1700	QF	27.7	38	20
18"	3258-1800	QF	29.5	40	20
20"	3258-2000	QF	32.5	44.4	18
22"	3258-2200	QF	35.4	47.5	18
24"	3258-2400	QF	38.6	51.5	18
26"	3258-2600	FLANGE	42.2	55	18
28"	3258-2800	FLANGE	45.2	59	18
30"	3258-3000	FLANGE	48.2	63	18
32"	3258-3200	FLANGE	51.2	67	18
34"	3258-3400	FLANGE	54.6	71	18
36"	3258-3600	FLANGE	58.2	74.7	18
38"	3258-3800	FLANGE	61.2	79	18
40"	3258-4000	FLANGE	64.2	83	18

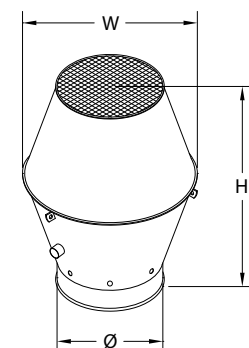

**VIEWING SPOOL
BUTTERFLY VALVE
BLEED IN VALVE
RADIAL ARMSAW HOOD**



QUICK-FIT
THE WORLD'S FASTEST DUCTING

VIEWING SPOOL

Ø	PART NO.	ENDS	LENGTH (L)	GAUGE
3"-12"	3205-XX00	QF	12.5	22
14"-18"	3205-XX00	QF	12.5	20

An acrylic tube allows operators to visually verify that material in the system is flowing freely.

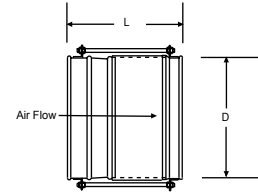

BUTTERFLY VALVE

Ø	PART NO.	ENDS	LENGTH (L)	GAUGE
3"-7"	3208-XX00	QF	8"	22
8"-10"	3208-XX00	QF	13"	22
11"-12"	3208-XX00	QF	13"	20
13"-16"	3208-XX00	QF	17"	20
17"-24"	3208-XX00	QF	23"	20

A locking quadrant handle enables users to regulate air volumes in clean air applications.

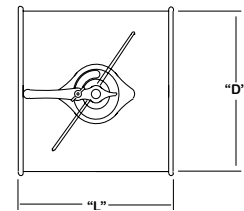

BLEED IN VALVE

Ø	PART NO.	ENDS	LENGTH (L)	NO. OF SLOTS	GAUGE
3"	3207-0300	QF	11"	2	24
4"	3207-0400	QF	11"	2	22
5"	3207-0500	QF	11"	3	22
6"	3207-0600	QF	11"	3	22
7"	3207-0700	QF	11"	4	22
8"	3207-0800	QF	11"	4	22
9"	3207-0900	QF	11"	5	22
10"	3207-1000	QF	11"	5	22
11"	3207-1100	QF	11"	5	22
12"	3207-1200	QF	11"	6	22
13"	3207-1300	QF	11"	6	20
14"	3207-1400	QF	11"	7	20
15"	3207-1500	QF	11"	7	20
16"	3207-1600	QF	11"	8	20
17"	3207-1700	QF	11"	8	20
18"	3207-1800	QF	11"	9	20
20"	3207-2000	QF	11"	10	20
22"	3207-2200	QF	11"	11	20
24"	3207-2400	QF	11"	11	20

Allows controlled amounts of ambient air to enter in order to balance the system.

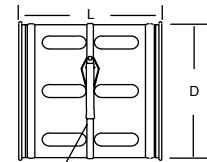

To Adjust, Loosen Clamp and Turn Outer Sleeve To Get Proper Air-flow Re-Clamp When Finished

RADIAL ARMSAW HOOD

Ø	PART NO.	ENDS
4"-6"	3229-0X00	QF

Used to collect dust from "Radial Arm Saws"

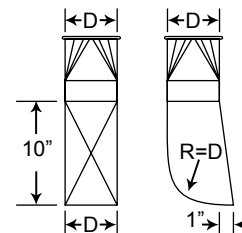



QUICK-FIT

THE WORLD'S FASTEST DUCTING

**SLIDING ACCESS PANEL
MIST RECYCLER**

SLIDING ACCESS PANEL

Ø	PART NUMBER	PIPE LENGTH/SLIDE LENGTH	ACCESS HOLE
6"	3103-0600-100000	59.25 inches/18 Inches	7" x 14"
7"	3103-0700-100000	59.25 inches/18 Inches	7" x 14"
8"	3103-0800-100000	59.25 inches/18 Inches	7" x 14"
9"	3103-0900-100000	59.25 inches/18 Inches	7" x 14"
10"	3103-1000-100000	59.25 inches/18 Inches	7" x 14"
11"	3103-1100-100000	59.25 inches/18 Inches	7" x 14"
12"	3103-1200-100000	59.25 inches/18 Inches	7" x 14"
13"	3103-1300-100000	59.25 inches/18 Inches	7" x 14"
14"	3103-1400-100000	59.25 inches/18 Inches	7" x 14"
15"	3103-1500-100000	59.25 inches/18 Inches	7" x 14"
16"	3103-1600-100000	59.25 inches/18 Inches	7" x 14"
17"	3103-1700-100000	59.25 inches/18 Inches	7" x 14"
18"	3103-1800-100000	59.25 inches/18 Inches	7" x 14"
20"	3103-2000-100000	59.25 inches/18 Inches	7" x 14"
22"	3103-2200-100000	59.25 inches/18 Inches	7" x 14"
24"	3103-2400-100000	59.25 inches/18 Inches	7" x 14"



The 7" dimension of the opening is measured around the pipe as shown.

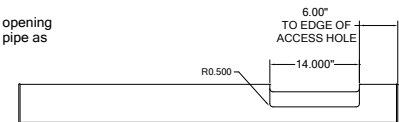

MIST RECYCLER

Ø	PART NO.	GAUGE	(A) INCH	(B) INCH	BAFFLE SIZE
3"	3192-0300	22	14	18	10" x 14"
4"	3192-0400	22	14	18	10" x 14"
5"	3192-0500	22	14	18	10" x 14"
6"	3192-0600	22	14	18	10" x 14"
7"	3192-0700	22	20	24	16" x 20"
8"	3192-0800	22	20	24	16" x 20"
9"	3192-0900	22	20	24	16" x 20"
10"	3192-1000	22	20	24	16" x 20"
12"	3192-1200	22	20	28	20" x 20"

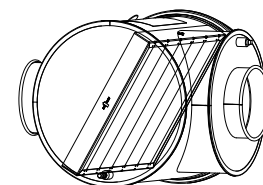
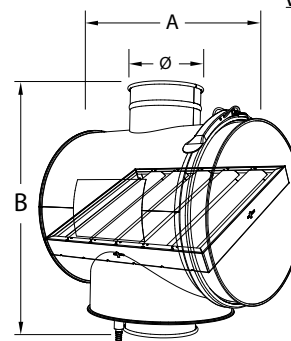
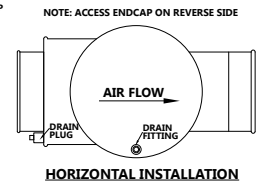
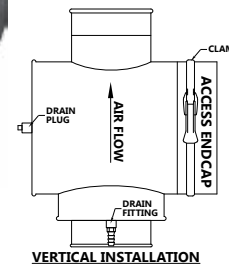

ROOF FLASHING

Ø	PART NO.	GAUGE
4-24"	3237-XX00-100000	20

Provides weather protection for roof penetration.

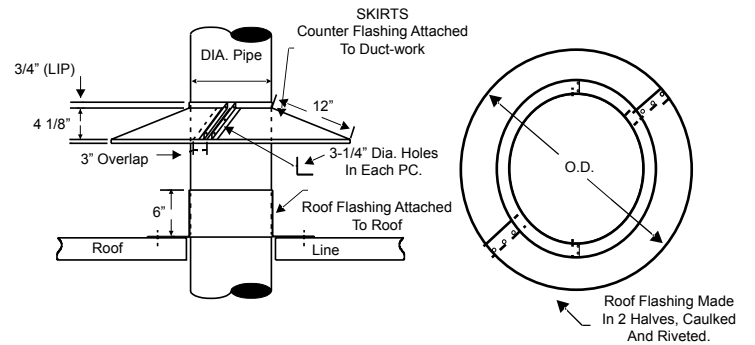
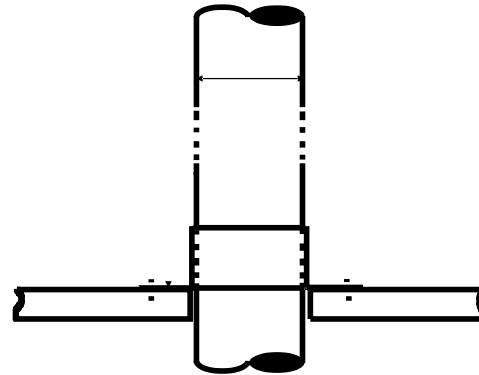

ROOF SKIRT

Ø	PART NO.	GAUGE
4-24"	3239-XX00-100000	20

Provides weather protection for Roof penetration..

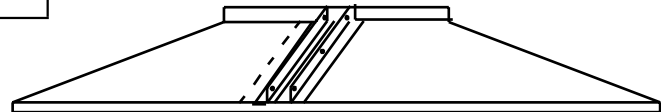

WALL FLASHING

Ø	PART NO.	GAUGE
4-24"	3238-XX00-100000	20

Provides weather protection for Wall penetration..

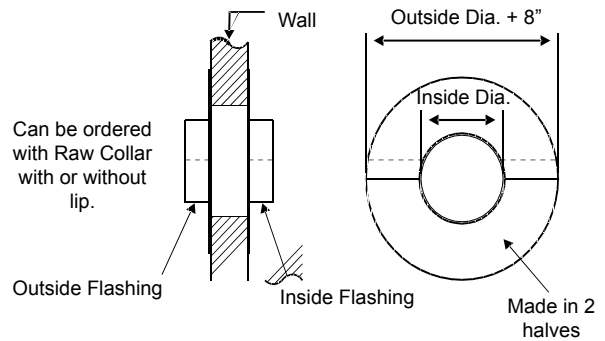



QUICK-FIT

THE WORLD'S FASTEST DUCTING

EXPLOSION ISOLATION FLAP

Application:

Material Types: Dry Dusts (not designed for combustible gas and vapors and hybrid mixtures of these substances.)

Kst Value of Dust < 200 Bar-M / Sec
NOT SUITABLE for greater than ST1 dust.

Transport Medium: Standard Air

Air Velocity In the Device: > than the minimum transport velocity of the conveyed dust.

Design conditions for ductwork and Air Material Separator (Dust Collector)

EIF Designed for Max. Reduced Pressure P _{red}	
Size	P _{red}
CARZ 6"-22"	0.5 bar
CARZ 24"-40" AF	0.3 bar

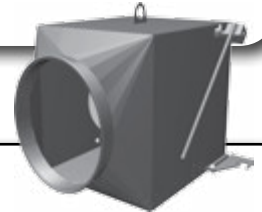

Installation:

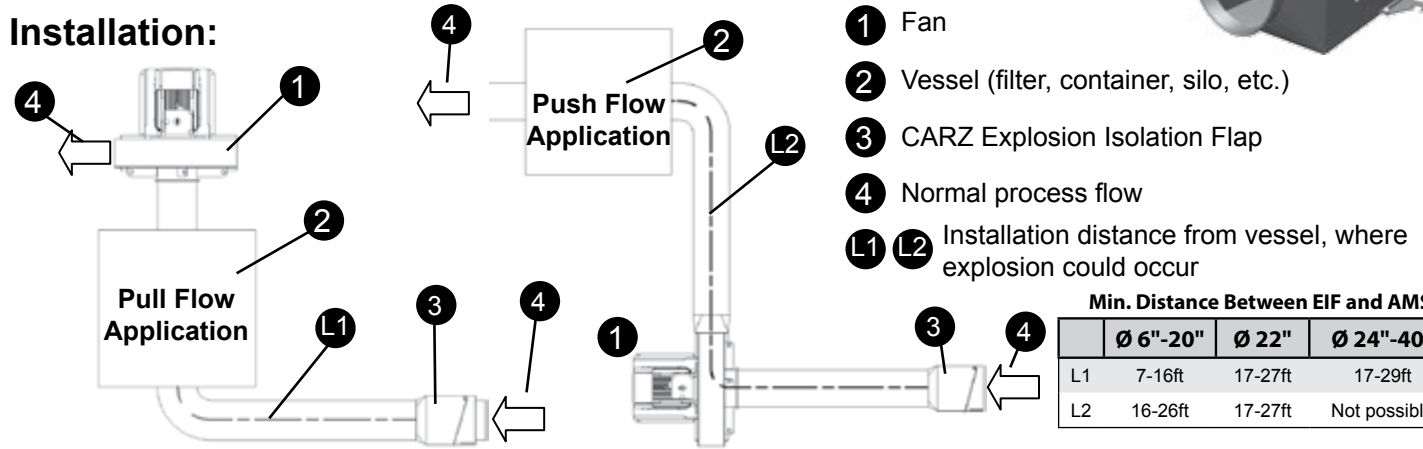

Min. Distance Between EIF and AMS

	Ø 6"-20"	Ø 22"	Ø 24"-40"
L1	7-16ft	17-27ft	17-29ft
L2	16-26ft	17-27ft	Not possible

Can only be mounted in the horizontal position

KST verification form required / Lead time is 25 working days after receipt.

Dimensions:

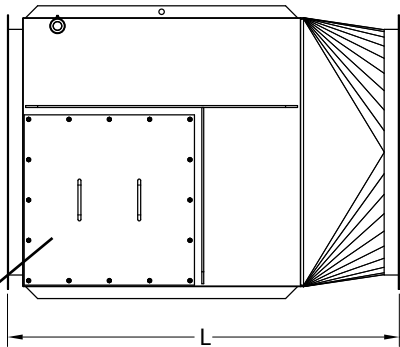
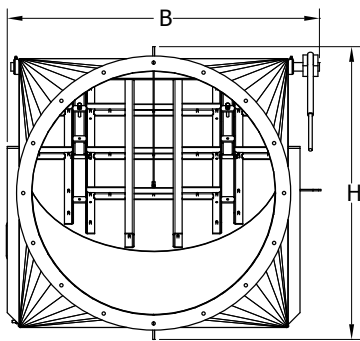

Inspection door

ACTUAL DIAMETER	LENGTH (L)	BODY (B)
6"	19 1/4"	16 7/8"
7"	20 1/8"	17 5/8"
8"	21"	18 7/16"
10"	23"	20 7/16"
12"	25 1/2"	23"
14"	27"	24 3/8"
16"	29"	26 3/8"
18"	31"	28 3/8"
20"	33"	30 1/4"
22"	42 1/4"	32"
24" AF	44 7/16"	34 3/4"
28" AF	48"	38"
32" AF	51 5/8"	41 1/2"
36" AF	55 1/2"	45 3/8"
40" AF	59 1/2"	49 3/8"

FUME ARM CUSTOM MANIFOLD



QUICK-FIT

THE WORLD'S FASTEST DUCTING

TDH FUME ARM

WORKING RANGE, FT	PART NO.	AIRFLOW, CFM	NOISE LEVEL AT HOOD, DB(A)
7	8690-0311	412-589	63-75
10	8690-0308	412-589	63-75
14	8690-0314	412-589	63-75
14	8690-0313	412-589	63-75

- A swivel allows the product to rotate 360°.
- The arm is flexible in all directions and simple to position.
- The product is equipped with a damper in the hood as standard.
- The hood on all models can be tilted in all directions.
- Maximum fume temperature 158°F.

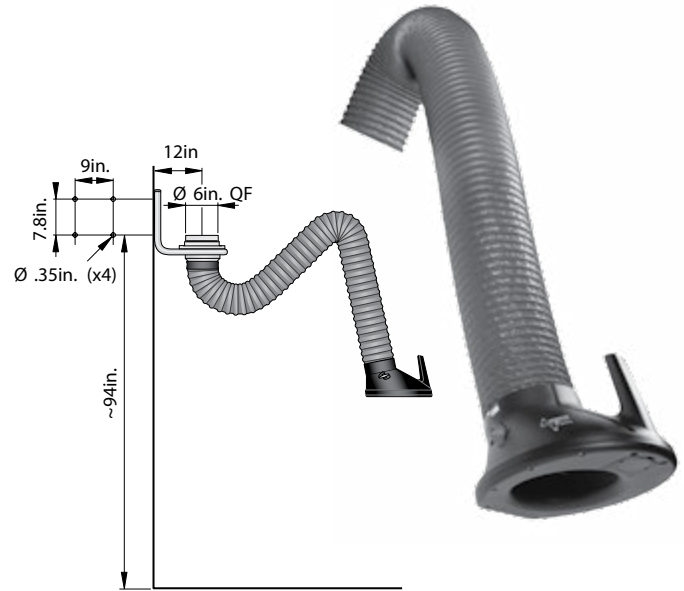

**CUSTOM MANIFOLDS ARE AVAILABLE.
CONTACT OUR SALES OFFICE FOR YOUR
PARTICULAR NEEDS.**

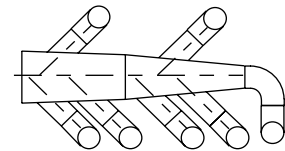

INSTRUCTIONS FOR INSTALLING AN ADJUSTABLE NIPPLE

Each QF pipe section is 5 ft. in length. To shorten to accommodate an existing span, an adjustable nipple is used.



STEP 1

Measure distance to be spanned.

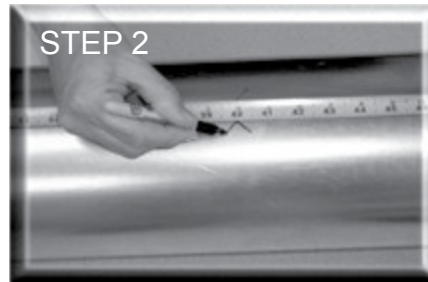

STEP 2

Mark distance to be spanned less 4".

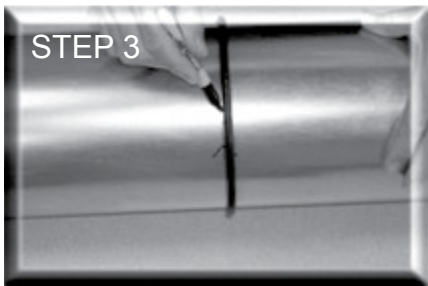

STEP 3

Use O-ring provided and mark for cut.



STEP 4

Drill access hole then cut with saw



STEP 5

Put O-ring on cut pipe, slide nipple over.

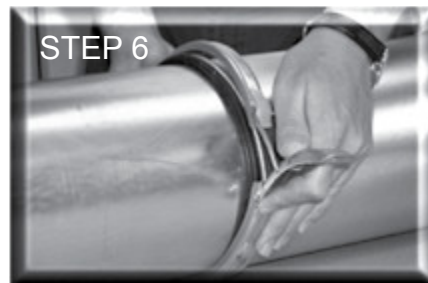

STEP 6

Snap clamp over O-ring and one end of nipple.

**FINISHED CONNECTION
USING THE ADJUSTABLE
NIPPLE ASSEMBLY.**

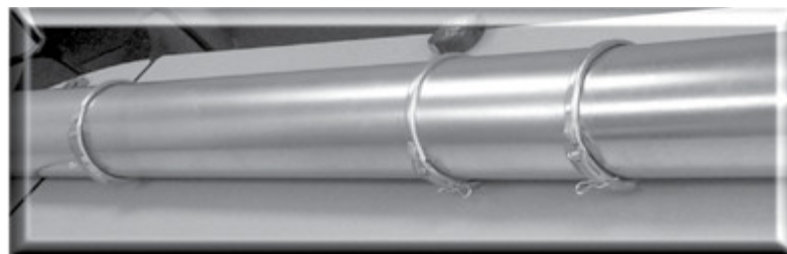

NOTE: KEEP CUT PIPE IN THE SAME DIRECTION AS THE AIR FLOW.

ORDERING NOTES:

Unless specified, 3" through 24" is QF, over 24" is flanged. Data is subject to change without notice. Stainless steel components requiring flanges will be supplied with SS flanges unless otherwise specified. Stainless steel components are manufactured with NO.304 SS. [Call for SS 316 Prices] Adding a SS after standard part numbers specifies a SS part. For special parts or items to be custom manufactured call for quotation.

SIZING A QF PIPE SYSTEM

QUESTION: Suppose that you have a 5" drop that rises and runs back to join with a 6" drop as sketched below. What size branch will you need? (Always work from your machines back toward the filter.)

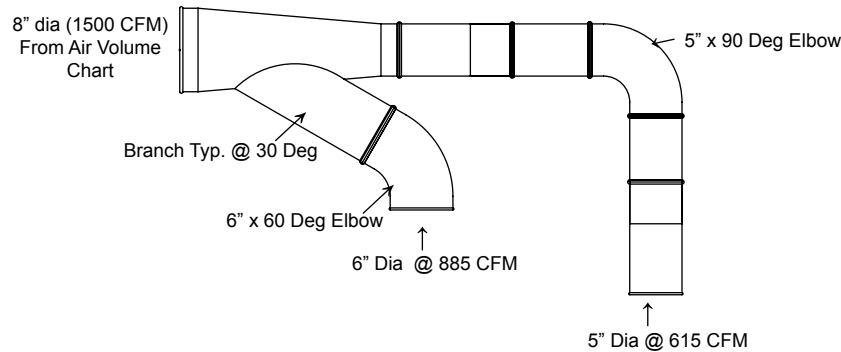

ANSWER: The 5" pipe carries 615 CFM at 4500 FPM, (See Chart). The 6" pipe will need 885 CFM at the same velocity (See Chart). Added together you have a total of (615 + 885) 1500 CFM coming together. Looking again at the chart under 4500 FPM, you find that 1500 CFM is not listed, but falls very close to the 1570 CFM listed for an 8" pipe. This indicates that the 5" joined to the 6" will require an 8" pipe to carry all of the material at the right velocity. The branch, therefore, will be 8" on the downstream end reducing down to a 5" with a 6" branching off of it. That is listed as a 8-6-5 branch.

DUCT AIR VOLUME IN CUBIC FEET PER MINUTE (CFM)											
VELOCITY IN FEET PER MINUTE (FPM)											
DUCT Ø	2000	2500	3000	3500	4000	4500	5000	5500	6000	6500	7000
3	100	125	150	170	195	220	245	270	295	320	345
4	175	220	260	305	350	395	440	485	525	570	615
5	275	340	410	475	545	615	680	750	820	885	955
6	395	490	590	685	785	885	980	1080	1180	1275	1375
7	535	670	800	935	1070	1205	1335	1470	1605	1735	1870
8	700	875	1050	1220	1395	1570	1745	1920	2095	2270	2445
9	885	1105	1325	1545	1765	1990	2210	2430	2650	2870	3090
10	1090	1365	1635	1910	2180	2455	2725	3000	3270	3545	3820
11	1320	1650	1980	2310	2640	2970	3300	3630	3960	4290	4620
12	1570	1965	2355	2750	3140	3535	3925	4320	4710	5105	5500
13	1850	2300	2770	3225	3685	4150	4610	5070	5530	5990	6450
14	2140	2675	3205	3740	4275	4810	5345	5880	6415	6950	7485
15	2450	3070	3680	4300	4900	5520	6130	6750	7360	7970	8590
16	2790	3490	4190	4885	5585	6285	6980	7680	8380	9075	9775
17	3150	3940	4730	5515	6300	7090	7880	8670	9450	10240	11030
18	3535	4420	5300	6185	7070	7950	8835	9720	10600	11485	12370
20	4365	5455	6545	7635	8725	9815	10910	12000	13090	14180	15270
22	5280	6600	7920	9240	10560	11880	13200	14520	15840	17160	18480
24	6285	7855	9425	10995	12656	14135	15710	17280	18850	20420	21995
26	7370	9210	11055	12900	14740	16580	18420	20270	22110	23950	25800
28	8550	10685	12820	14960	17100	19230	21310	23500	25650	27780	29920
30	9800	12260	14700	17170	19625	22080	24530	26990	29440	31890	34350
32	11160	13950	16750	19541	22330	25120	27910	30700	33490	36280	39070
34	12600	15755	18905	22055	25210	28360	31510	34660	37810	40965	44115
36	14130	17665	21195	24730	28260	31800	35325	38860	42390	45925	49455
38	15745	19680	23615	27550	31490	35425	39360	43295	47230	51170	55100
40	17445	21800	26170	30530	34890	39250	43610	47975	52330	56700	61055



QUICK-FIT
THE WORLD'S FASTEST DUCTING



Installation Tips

STEP ONE: Make Sure Your Shipment is Complete and Undamaged. Nordfab ships most orders FOB Nordfab or "Free On Board." This means that it is your responsibility to ensure that the materials you receive do not have freight damage and that the carrier has delivered all the boxes in your shipment.

Inspect all boxes for outward damage BEFORE signing for receipt. The boxes should be strapped to a pallet, and not be crushed, torn or otherwise damaged. If you find damage, either refuse the shipment or note the issue on the receipt you sign. Unless you do this, any future claims will be virtually impossible to collect.

Additionally, before signing for your shipment, ensure that all boxes are accounted for. You can find the number of boxes in a shipment by checking the delivery receipt the driver will ask you to sign. Again, note any discrepancies before signing. **IMPORTANT SAFETY NOTE:** Beware of the sharp metal staples used to seal the shipping boxes.

STEP TWO: Understanding the Packing Documents. Nordfab packs boxes with the goal of reducing shipping costs, not in the order the parts are needed. Do not simply tear into the boxes and begin removing parts. At least one box on each order will contain Nordfab's "Packing List." Locate these documents before opening any boxes as it will give you details as to what is in each box. Avoid opening boxes until you need them to reduce the chance of parts being lost or damaged on site. If you have any problems, call your dealer as he is in the best position to rectify any problems with your particular order. Have all packing documentation with you when you call.

STEP THREE: Preparing to Install Your Ducting. It is important for the installer to understand the layout the system designer planned for the ducting. Follow all local codes and regulations and note loading capabilities of structures to ensure the ducting is properly supported and that the building can carry the ducting system. If your installer doesn't understand the layout, he will not have all the parts necessary to complete the job. If you do not have a clear understanding or drawing of the system you are about to install, please call the person who designed the system before you begin work.



STEP FOUR: Laying out the duct. Begin by laying the system out on the floor below where it will hang. Remember that two parts that connect will often not be in the same box, so this step dramatically reduces the time it takes to complete the job once the installation begins.

NOTE: This is the step where you could possibly find that you do not have all the parts necessary to complete the job. In that case, contact your dealer immediately so that he can get a head start on getting you the needed parts as well as help you verify that your layout matches the one planned by the system designer.

STEP FIVE: The Adjustable Nipple. One of the most important benefits of Quick-Fit is that it is not necessary to take exact measurements before cutting each piece of pipe. The adjustable nipple is an 11-inch section of pipe that has a slightly larger diameter than a standard Q-F duct.

STEP SIX: Supporting Your Ductwork. Nordfab has a variety of duct hanging devices, but it is your responsibility to ensure the safety of all ducting. Please check with local agencies to ensure that your ducting is supported in a way that meets local codes. When determining the weight your ceiling and hangers must support, always allow for the ducting being 100 percent clogged with whatever material is being conveyed.



STEP SEVEN: Pre-Stretch Your Clamps. The Nordfab clamps are designed to provide a tight seal, which means that they also require some pressure to close. By pre-stretching the clamp around the rolled edge of a single piece of pipe, you can make it much easier to close when you connect two pieces together.

STEP EIGHT: Clamp As Many Parts Together As Possible on the Ground. It is much faster and easier to close the clamps on stable ground than on a scaffold. Therefore, many installers connect two or three pieces of ductwork together on the floor before lifting them into place.

STEP NINE: Use the Cotter Pins. After closing each clamp, install one of the enclosed cotter pins into the hole as shown. This ensures that the clamp cannot come open unexpectedly. Install the cotter pin as soon as a clamp is closed and beware of clamps until the cotter pin is safely installed. **IMPORTANT SAFETY NOTE:** On very rare occasions, unpinned clamps can spring open unexpectedly which can cause the pipe to drop. Additionally, the handles on unpinned clamps have been known to cause injury when they sprang open.

Useful Tools and Important Safety Information:

Always use proper safety equipment when installing Quick-Fit

- Work Gloves.
- Safety Helmet
- File
- Level
- Eye & Ear Protection
- Cutting Device
- Scaffolding
- Plumb